

iNELS

Wireless electro-installation



elkoop.com/wireless





ELKO EP

ELKO EP have been your partner in the field for 30 years, developing and manufacturing the highest quality electronic devices for electroinstallation as well as smart system for residential and building automation.

ELKO EP employs more than 350 people across 15 foreign branches and exports its products to more than seventy countries. Company of the Year, Visionary of the Year, Superbrands and Global Exporter of the Year are just some of the awards we have received throughout the years as we consistently strive to move forward in the field of innovation and development.

Millions of relays, thousands of smart homes, hundreds of buildings and many satisfied customers - This is ELKO EP; a traditional company based in the center of Europe, where own development, production, logistics, and service are at the forefront of our focus.

Facts & stats

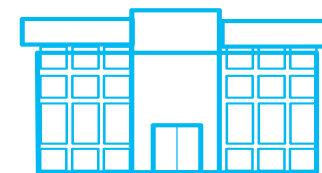

30 %

Czech

40 %

export

30 %

branches



WORLDWIDE

11 branches
3 franchises
70 export countries



350

employees
in holding



30 000 +

iNELS
installations



30 000 000 +

manufactured
products

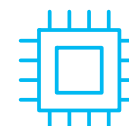

R&D

continuosly
innovative



MANUFACTURER

fully automated
complete proces



SUPPORT

24 / 7 / 365

World leader
in DIN rail relays production

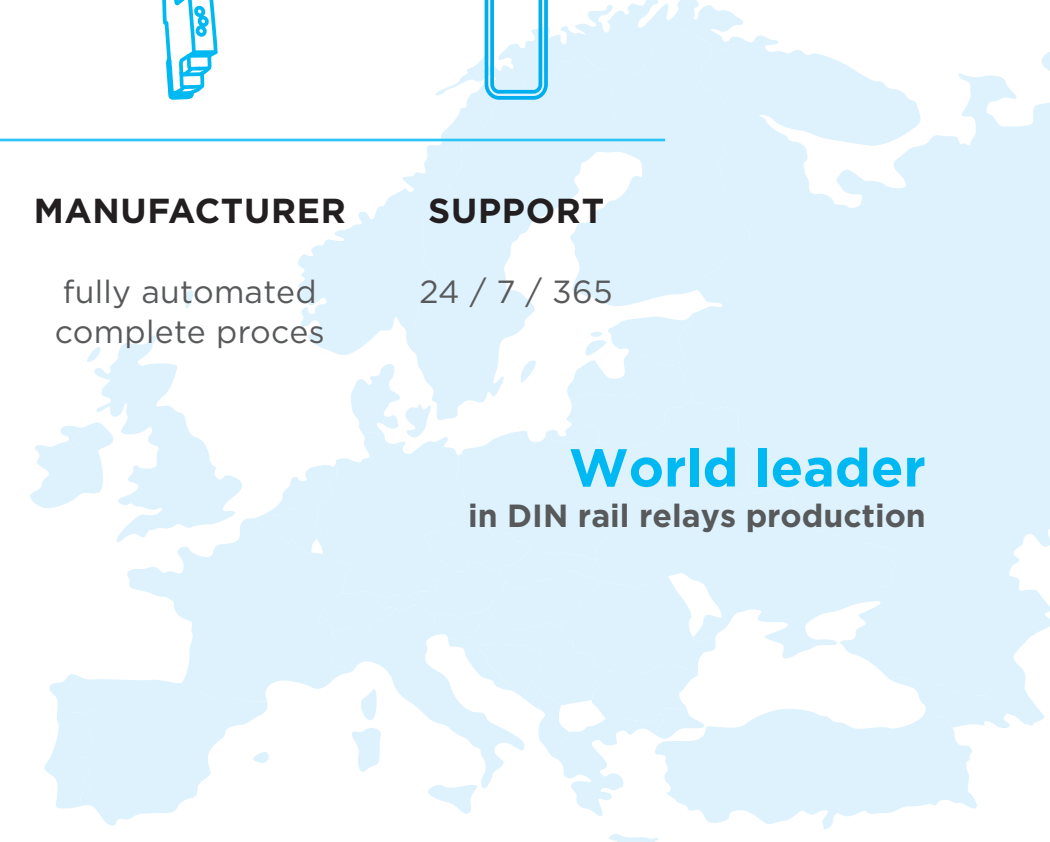

System scalability

UNITS

Individual elements of the iNELS system for personalised installation.

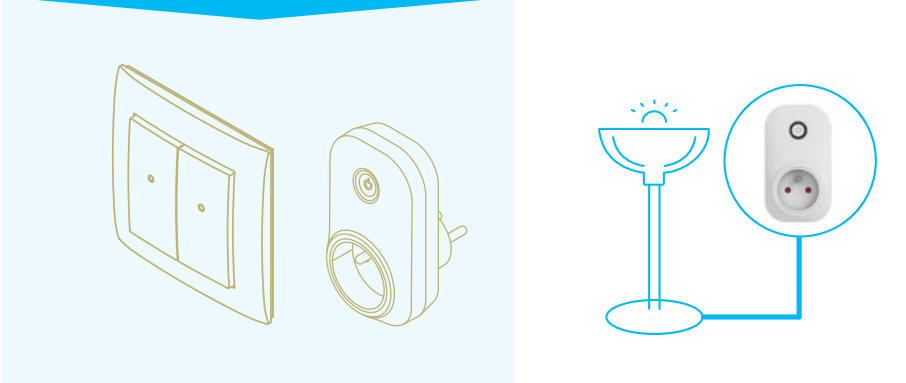

KITS

Pre-Set elements for everyday applications.

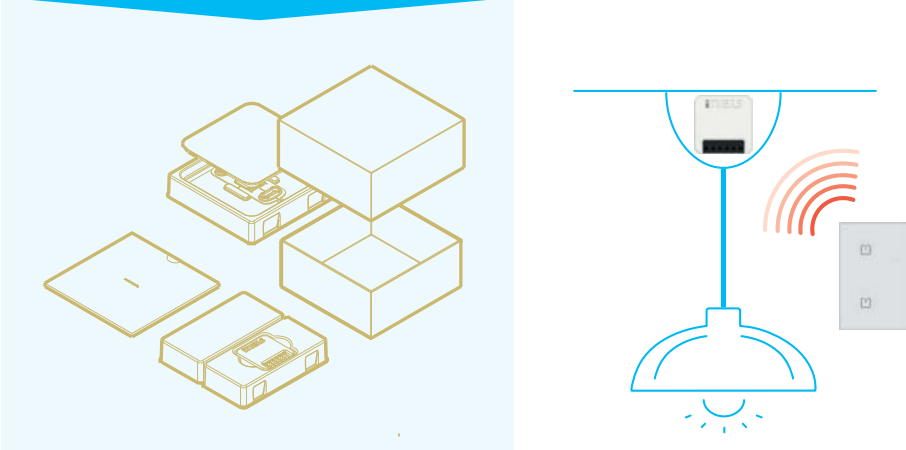
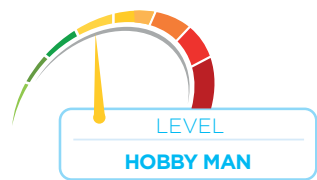

CONNECTED HOME

A simple solution to turn your house into a smart home, without any structural intervention.

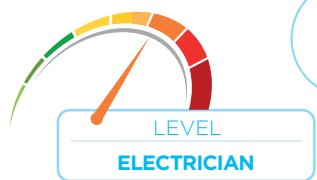

SMART BUILDING

When using wireless elements is faster and cheaper.

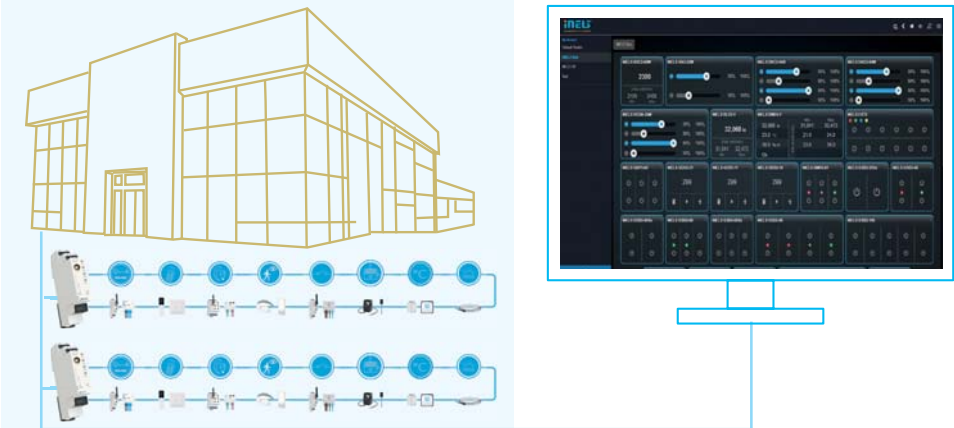
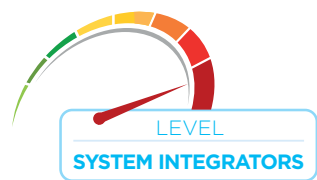

Many ways to controll...



On wall button controllers

RFWB-20 / RFWB-40

- 2 or 4 buttons
- simple installation – can be attached or fixed anywhere
- in LOGUS⁹⁰ design frames (natural materials and colour combinations)

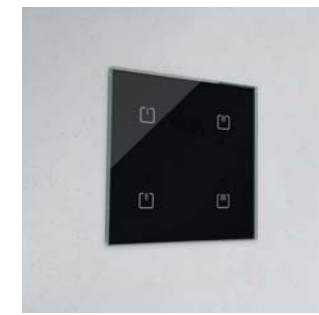

Glass touch controller

RFGB-20 / RFGB-40

- wall controller in elegant glass design
- 2 or 4 buttons
- in black or white glass sharp or rounded edges



Wireless touch unit

RF Touch-2/BE, RF Touch-2/BR

- wireless touch unit for flushed mount
- it will become a central, wireless intuitively controlled home
- coloured 4" TFT display
- eLAN-RF gateway included



RF Key

RF Key-40B/W

- 4 or 6 buttons controller
- pocket controller for every day
- in colour white or black



Matter compatibility



iNELS Wireless: units overview	8
Controllers	
RFWB-20/G, RFWB-20/GB, RFWB-40/G, RFWB-40/GB On-wall button controllers – PAIRING BUTTON	14
RFOWB-20 Outdoor controller, 2 buttons – (IP65)	15
RFGB-20/W, RFGB-20/B, RFGB-40/W, RFGB-40/B Glass touch controllers, SHARP – PAIRING BUTTON	16
RFSW-62, RFSW-262 Glass touch controller with output relays – NEW!	17
RFDW-71, RFDW-271 Glass touch controller with dimmer – NEW!	18
RFGB-220/W, RFGB-220/B, RFGB-240/W, RFGB-240/B Glass touch controllers, ROUND – PAIRING BUTTON	19
RF Pilot/W, RF Pilot/A Remote RF controller with display	20
RF KEY-40/W, RF KEY-40/B, RF KEY-60/W, RF KEY-60/B Key fob – PAIRING BUTTON	22
Switches	
RFSAI-61B Switch unit, 1-channel – (BOX)	23
RFSAI-61BPF-SL – NEW! , RFSAI-61B-SL, RFSAI-62B-SL, RFSAI-11B-SL Switch units with the inputs for external buttons – (BOX-SL)	24
RFJA-32B-SL Switch unit for shutters – (BOX-SL)	25
RFSAI-61MI, RFSAI-61M Switch unit, 1 channel – (1-MODUL DIN rail)	26
RFSAI-66MI, RFSAI-66M Switch unit, 6 channels – (3-MODUL DIN rail)	27
RFUS-61 Switch unit with increased protection – (IP65)	28
RFSC-61N Switch socket-plug – (PLUG)	29
Dimmers	
RFDAC-71B-SL Analog controller, 0(1)-10V – (BOX)	30
RFDEL-71B-SL Universal dimmer, 1-channel – (BOX-SL)	31
RFDALI-32B-SL, RFDALI-04B-SL DALI controller, for 32/4 addresses – (BOX-SL) – NEW!	32
RFDEL-71M Universal dimmer, 1-channel – (3-MODUL DIN rail)	33
RFDEL-76M Universal dimmer, 6-channels – (6-MODUL DIN rail)	34
RFDA-73M/RGB Dimmer for LED (RGB) strips, 3-channels – (3-MODUL DIN rail)	35
RFDS-71N Dimming socket-plug – (PLUG)	37
Temperature control	
RFTC-3 Glass touch thermostat for fancoils – NEW!	38
RFTC-10/G System temperature controller – (LOGUS ⁹⁰)	40
RFTC-50/G Autonomous temperature controller – (LOGUS ⁹⁰)	41
RFSTI-11B-SL Switch unit with external temperature sensor – (BOX-SL)	42
RFTI-20 Temperature and humidity sensor – (SURFACE)	43
RFATV-2 Wireless thermostatic valve	44
TC, TZ Temperature sensors	45
Converters	
RFIM-40B/BP-SL, RFIM-40B/230-SL Input contacts converter – (BOX-SL) – PAIRING BUTTON	46
RFSG-1M Input contact converter (1-MODUL DIN rail) – PAIRING BUTTON	47
RFTM-1 Pulse converter – (IP65)	48
Detectors	
RFSF-100 Flood detector	49
RFSOU-1 Twilight switch – (IP65)	50
RFWD-100 Window/door detector	51
RFMD-100 Motion detector	52
RFMD-200 Motion detector for ceiling mounting – NEW!	53
RFSLT-S3 Wireless hydrostatic level sensor – (IP65) – NEW!	54

System units	
RF Touch-2/BE, RF Touch-2/BR Wireless touch unit – NEW!	56
eLAN-RF-103 Smart RF gateway MQTT	58
RFRP-20N Repeater to extend the range – (PLUG)	59
MATTER	
RFWB-40G/MT On-wall button controllers, 4 buttons MATTER – (LOGUS ⁹⁰)	60
RFGB-40B/MT, RFGB-40W/MT Glass touch controller – 4 buttons, SHARP MATTER	61
RFSAI-62B-SL/MT Switch unit with inputs for external buttons MATTER – (BOX-SL)	62
RFDEL-71B-SL/MT Universal dimmer MATTER	63
RFMD-200/MT Motion detector for ceiling mounting MATTER	64
RFWD-100/MT Window/door detector MATTER – NEW!	65
HRESK	
RFGS-30/S Infront of door hotel room unit – NEW!	68
RFSW-62/S Glass touch wireless controller with symbols – NEW!	69
RFSAI-266M Switch unit for fancoil control – NEW!	70
RFSAI-161B Lighting control unit with pair detectors and external button input – (BOX)	71
RFSTI-111B Overheating/overcooling switch unit with advanced functions – (BOX)	73
Accessories	
AN-I Internal antenna	75
RFAP/USB Service Key	75
AN-E1 External antenna	76
AN-E3 External antenna	76
MS Sensors for RFTM-1	77
WS Sensors for RFTM-1	77
LS Sensors for RFTM-1	77
Overview of functions	
Applications	78
Voice assistants	80
Protocol and compatibility	81
Product loadability	82
Pairing controllers with iNELS Wireless devices	84
Setting the functions on the controllers	86
Installation possibilities	87
Product dimension	88
Scope Architecture	90

Controllers



RFWB-20/G – white
RFWB-20/GB – black
On-wall button controller
– 2 buttons



RFWB-40/G – white
RFWB-40/GB – black
On-wall button controller
– 4 buttons



RFOWB-20
Outdoor controller
– 2 buttons



RF KEY-40/W – white
RF KEY-40/B – black
Key fob – 4 buttons



RF KEY-60/W – white
RF KEY-60/B – black
Key fob – 6 buttons



RF Pilot/W – white
RF Pilot/A – anthracite
Remote Wireless controller
with display



RFGB-20/W – white
RFGB-20/B – black
Glass touch controller
SHARP – 2 buttons

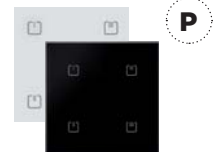

RFGB-40/W – white
RFGB-40/B – black
Glass touch controller
SHARP – 4 buttons



RFGB-220/W – white
RFGB-220/B – black
Glass touch controller,
ROUND – 2 buttons



RFGB-240/W – white
RFGB-240/B – black
Glass touch controller,
ROUND – 4 buttons



RFSW-62/B – black glass, SHARP
RFSW-262/W – white glass, ROUND
Glass touch controller
with output relays



RFDW-71/B – black glass, SHARP
RFDW-271/W – white glass, ROUND
Glass touch controller
with dimmer

Legend:



NEW

PAIRING
BUTTONINCREASED
PROTECTION

MATTER



MQTT

Switch units



RFS-61B
Switch unit, 1 channel
– 1x 16 A, multifunction



RFSAI-61BPF-SL
Switch unit with inputs for
external buttons – 1x 8 A,
multifunction, galvanically
separated



RFSAI-11B-SL
Switch unit with inputs for
external buttons – 1x 8 A,
singlefunction



RFSAI-61B-SL
Switch unit with inputs for
external buttons – 1x 8A,
multifunction



RFSAI-62B-SL
Switch unit with inputs for
external buttons 2-channels,
2x 8 A (total), multifunction



RFJA-32B-SL
Switch unit for shutters,
2x 8 A



RFS-66MI
Switch unit, 6 channels with
integrated antenna
– multifunction, 6x 8 A



RFS-61MI
Switch unit, 1 channel with
integrated antenna
– multifunction, 1x 16 A



RFS-66M
Switch units, 6 channels
– multifunction, 6x 8 A



RFS-61M
Switch unit, 1 channel – multi-
function, 1x 16 A



RFUS-61
Switch unit with increased
protection, 1x 12 A,
multifunction



RFSC-61N
Switching socket-plug,
– 1x 16 A, multifunction

Dimmers



RFDAC-71B-SL
Analog controller,
0(1)-10 V



RFDALI-32B-SL
RFDALI-04B-SL
DALI controller,
for 4/32 DALI addresses



RFDEL-71B-SL
Universal dimmer
1-channel – 1x 300 VA
– R, L, C, LED, ESL



RFDEL-71M
Universal dimmer,
1-channel – 1x 600 VA
– R, L, C, LED, ESL



RFDEL-76M
Universal dimmer,
6-channels – 6 x 150 VA



RFDA-73M/RGBW
Dimmer for LED (RGB) strips,
3-channels



RFDS-71N
Dimming socket-plug

Temperature control



RFTC-3
Glass touch thermostat for fancoils



RFTC-10/G
System temperature controller



RFTC-50/G
Autonomous temperature controller



RFSTI-11B-SL
Switch unit with external temperature sensor



TC TZ
Temperature sensors



RFATV-2
Wireless thermostatic valve



RFTI-20
Temperature and humidity sensor

Converters



RFIM-40B/BP-SL
4 input contacts converter battery powered



RFIM-40B/230-SL
4 input contacts converter AC 230 power supply



RFSG-1M
Input contact converter -1x permanent contact



RFTM-1
Puls converter

Detectors



RFSF-100
Flood detector



RFSOU-1
Twilight switch



RFWD-100
Window/Door detector



RFMD-100
Motion detector



RFSLT-S3
Wireless hydrostatic level sensor



RFMD-200
Motion detector

System units



eLAN-RF-103
Smart RF gateway with LAN



RFRP-20N
Repeater to extend the range



RF Touch-2/BE
RF Touch-2/BR
Wireless touch unit - flush mounted

Matter



RFWB-40G/MT
On-wall button controller - 4 buttons



RFGB-40B/MT - black glass
RFSW-40W/MT - white glass
Glass touch controller - 4 buttons, SHARP / MATTER



RFSAI-62B-SL/MT
Switch unit with inputs for external buttons MATTER, 2x 8 A (total)



RFDEL-71B-SL/MT
Universal dimmer, 1-channel - 1x 300 VA, MATTER



RFWD-100/MT
Window/Door detector MATTER



RFMD-200/MT
Motion detector MATTER

Hotel Retrofit (HRESK)

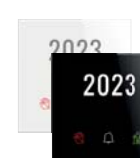

RFGS-30/SB - black glass
RFGS-30/SW - white glass
Infront of door hotel room unit



RFSW-62/SB - black glass
RFSW-62/SW - white glass
Wireless touch glass remote control with symbols



RFSA-266M
Switch unit for fancoil control



RFSAI-161B
Lighting control unit with pair detectors and external button input



RFSTI-111B
Overheating/overcooling switch unit with advanced functions

Accessories



RFAF/USB
Service Key



AN-I
Internal antenna
Gain: 2.1 dBi



AN-E
External antenna
Gain: 5 dBi



AN-E3
External antenna
Gain: 3 dBi, IP67



Extension cable for external antenna
10 m



- RFIO/RFIO2 - radiofrequency protocol bidirectional
- Wi-Fi
- LAN

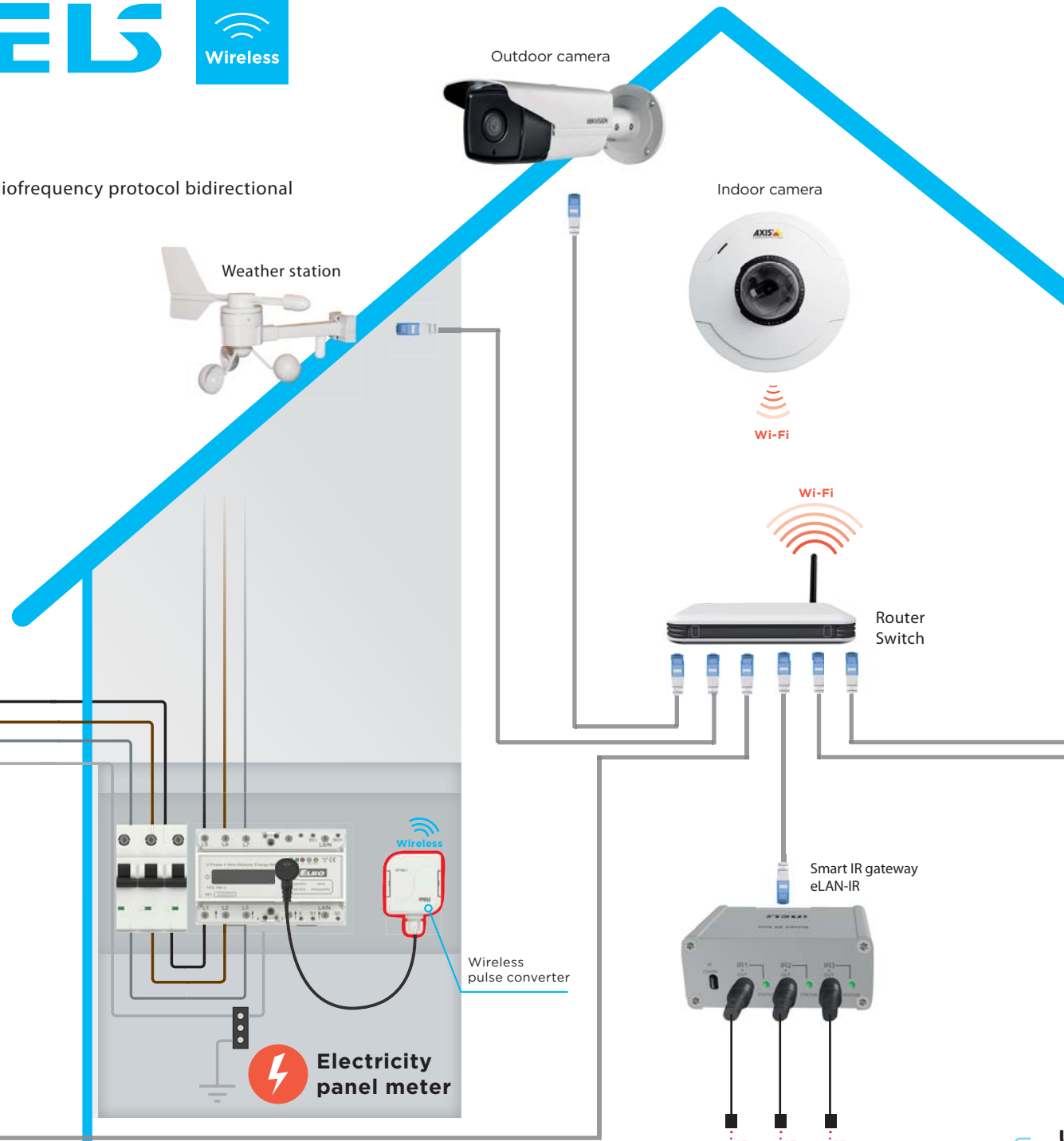

SW/APP



Controllers:

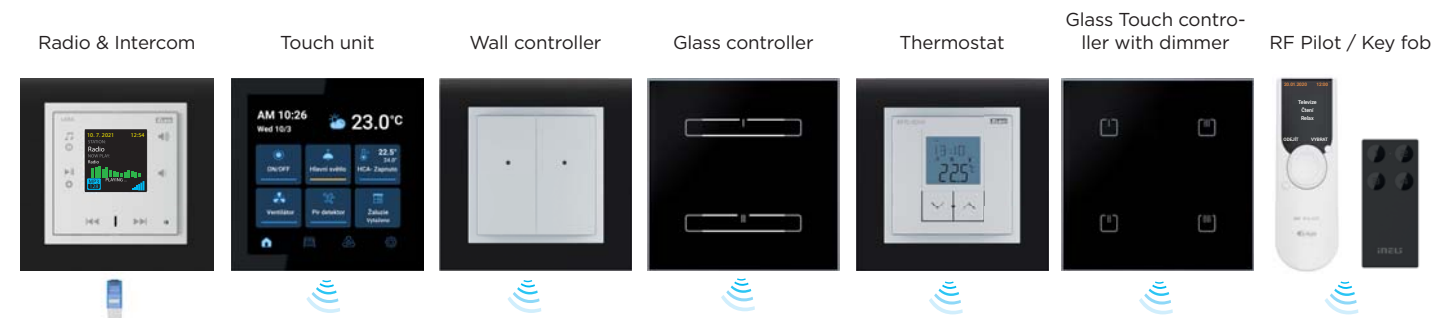

Detectors:

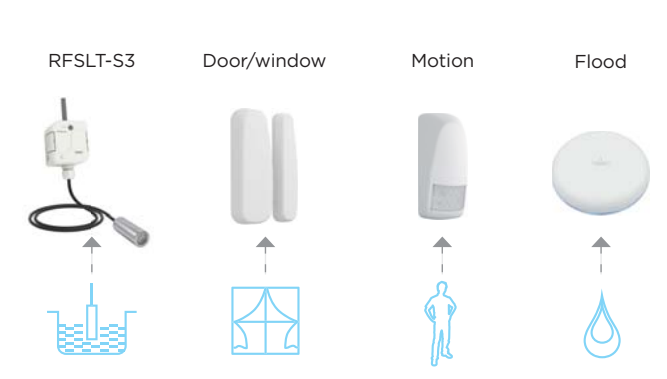

Sensors:



Units:

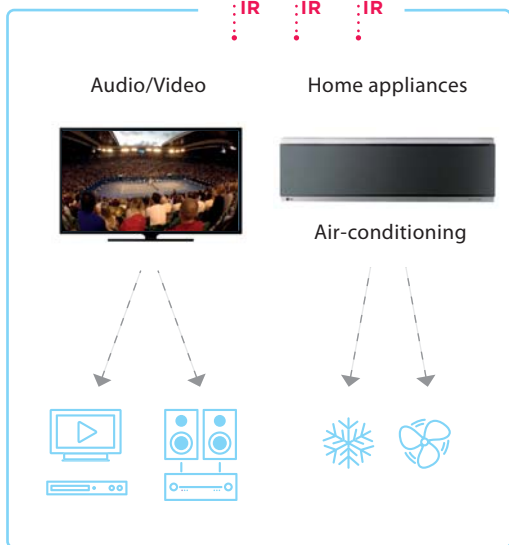
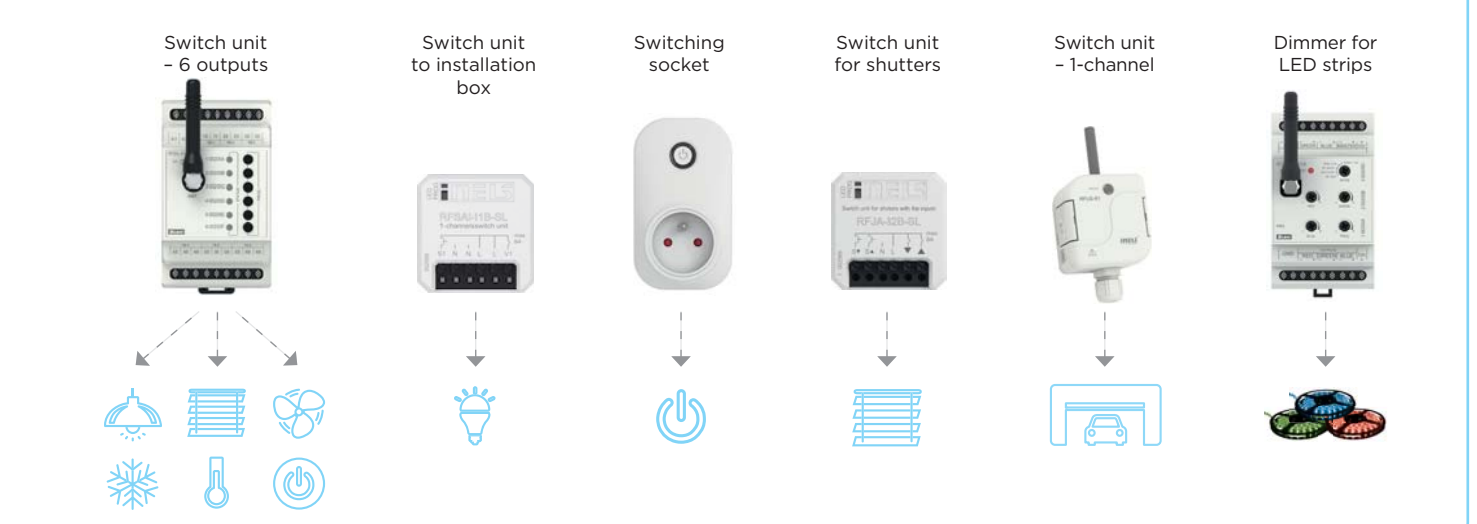



EAN code:
 RFWB-20/G: 8595188140379 RFWB-20/GB: 8595188191616
 RFWB-40/G: 8595188140607 RFWB-40/GB: 8595188191623

Technical parameters RFWB-20/G(GB) RFWB-40/G(GB)

Supply voltage:	3 V CR 2032 battery	
Battery life:	around 5 years based on frequency of use	
Transmission indication:	red LED	
Number of buttons:	2	4
Communication protocol:	RFIO	
Frequency:	866–922 MHz (for more information see p. 81)	
Signal transmission method:	unidirectionally addressed message	
Range:	in open space up to 200 m	

Other data

Operating temperature:	-10 to +50 °C	
Operating position:	any	
Mounting:	glue/screws	
Protection:	IP20	
Contamination degree:	2	
Dimensions frame		
- plastic:	85 x 85 x 16 mm	
- metal, glass, wood, granite:	94 x 94 x 16 mm	
Weight (plastic):*	38 g	39 g
Related standards:	EN 60730, EN 63044, EN 300 220, EN 301 489	

- On-wall button controller is used to control switches and dimmers (lights, gate, garage door, blinds, etc.).
- **RFWB-20/G(GB)**: two buttons enable control of two units independently.
- **RFWB-40/G(GB)**: four buttons enable control of four units independently.
- The flat design with level base makes it ideal for fast installation on any surface (fixation with adhesive or screws in the installation box).
- When pressing the button, it sends a set signal (ON/OFF, dimming, time switching OFF/ON, blinds up/down).
- Sending a command is indicated by a red LED.
- In LOGUS[®] switch frame design (plastic, glass, wood, metal, stone).
- Battery power supply (3 V CR 2032 battery - included in the supply) with battery life of around 5 years based on frequency of use.
- Range up to 200 m (in open space), if the signal is insufficient between the controller and unit, use the signal repeater RFRP-20N or protocol component RFIO2 that support this feature.
- RFWB enables communication (RFIO2) and can thus communicate with the CU3-02M.
- Attention: The controller is paired with the elements using the pairing button. Ord. codes for controllers with pairing button: RFWB-20/G Order No.: 8502, RFWB-40/G Order No.: 8489, see Pairing controllers on p. 84.

Device description

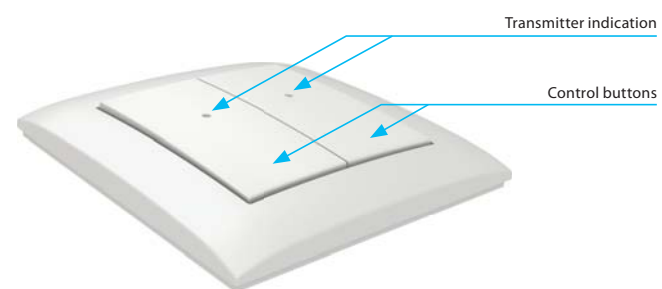

EAN code:
 RFOWB-20: 8595188181471

Technical parameters RFOWB-20

Supply voltage:	3 V CR 2032 battery
Battery life:	around 5 years based on frequency of use
Transmission indication:	Integrated red LED
Number of buttons:	2
Communication protocol:	RFIO
Frequency:	866–922 MHz (for more information see p. 81)
Signal transmission method:	unidirectionally addressed message
Range:	in open space up to 200 m

Other data

Operating temperature:	-10 to +50 °C
Mounting:	screws/double sided tape
Colour design:	white (RAL 9003)
Protection:	IP65
Contamination degree:	2
Dimensions frame:	64 x 74 x 44 mm
Weight:	112 g
Related standards:	EN 60730, EN 63044, EN 300 220, EN 301 489

Device description

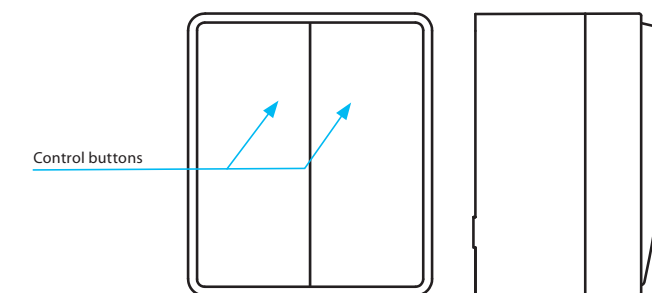

- The wireless push-button controller with IP65 protection is used to control iNELS Wireless components and protect them from the outdoor environment.
- 2 buttons allow (independently of each other) control of an unlimited number of components (actuators).
- The controller is suitable for control from the pool, garden, terrace, and pergola. It can be used as an uncovered bell button.
- Fastening with screws or double-sided tape.
- Battery power supply (3 V CR 2032 battery - included in the supply) with battery life of around 5 years based on frequency of use.
- Pairing controllers on p. 84

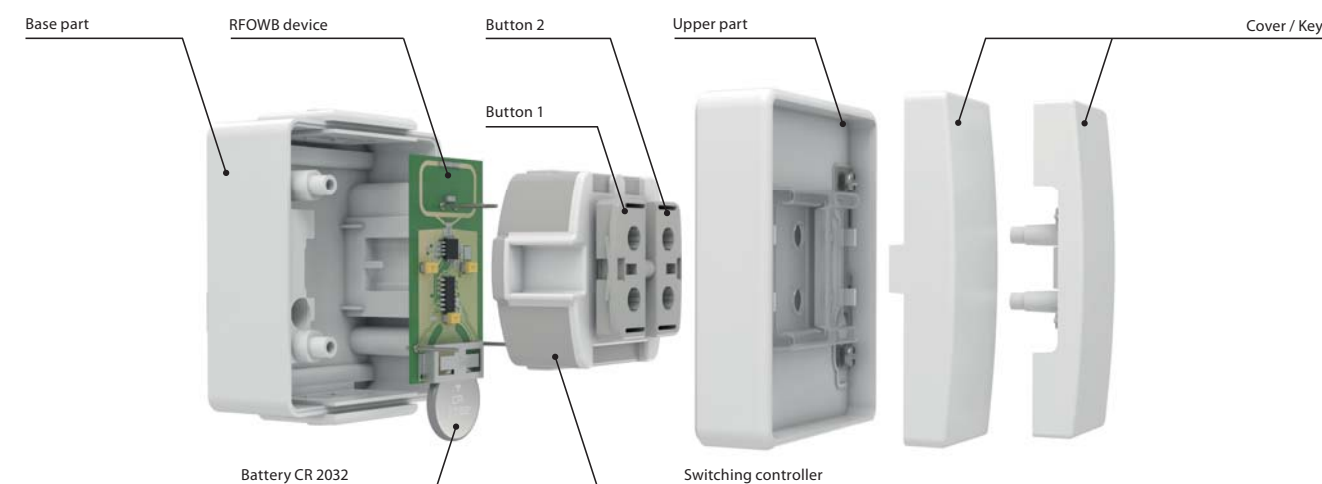
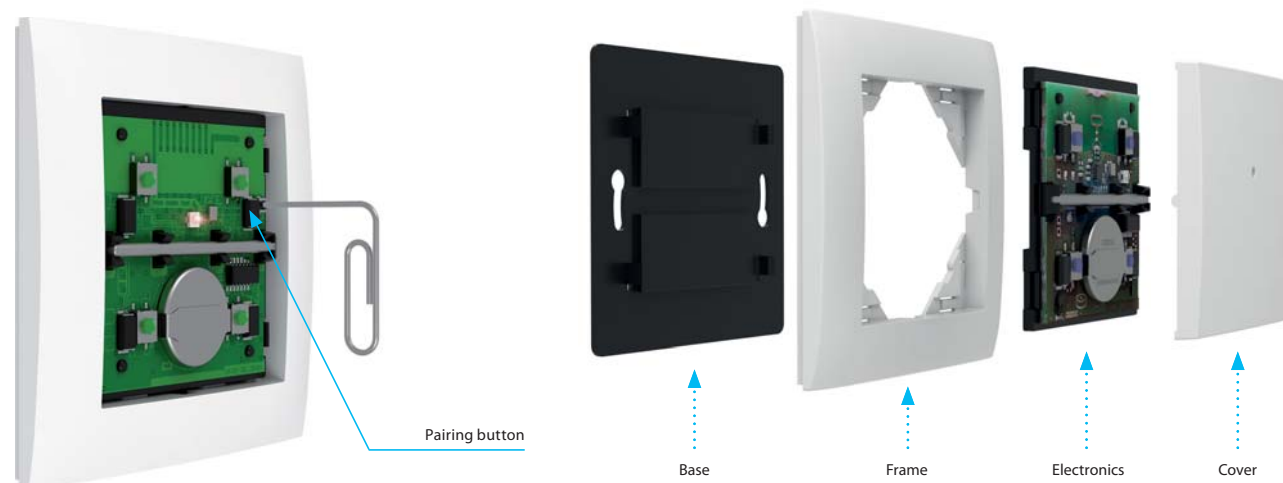

RFWB-20/GB

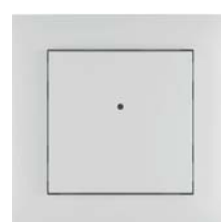

RFWB-20/G



RFWB-40/GB

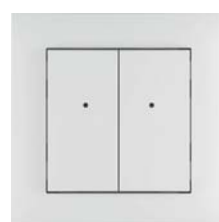

RFWB-40/G

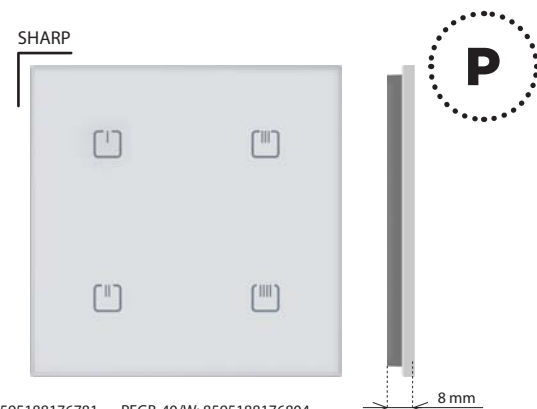

RFGB-20/W: 8595188176781 RFGB-40/W: 8595188176804
RFGB-20/B: 8595188176798 RFGB-40/B: 8595188176811

Technical parameters	RFGB-20	RFGB-40
Supply voltage:	2x 3 V CR 2032 batteries	
Battery life:	around 2 years based on frequency of use	
Transmission indication:	red LED	
Number of capacitive buttons:	2	4
Communication protocol:	RFIO	
Frequency:	866–922 MHz (for more information see p. 81)	
Signal transmission method:	unidirectionally addressed message	
Range:	in open space up to 200 m	
Other data		
Operating temperature:	-10 to +50 °C	
Operating position:	any	
Mounting:	glue/screws	
Protection:	IP20	
Contamination degree:	2	
Dimensions:	94 x 94 x 8 mm	
Weight:	107 g	107 g
Related standards:	EN 60730, EN 63044, EN 300 220, EN 301 489	

- The glass touch controller is a design iNELS Wireless unit and is available in elegant black and white variants.
- Only 8 mm thick.
- **RFGB-20:** 2 capacitive buttons allows to control 2 devices.
- **RFGB-40:** 4 capacitive buttons allows to control 4 devices.
- When pressing the button, it sends a set signal (ON/OFF, dimming, time switching OFF/ON, blinds up/down). Sending a command is indicated by a red LED.
- Option of setting light scenes, where with a single press, you can control units of iNELS Wireless.
- The rear base allows to be attached to installation using screws, double-sided tape or keeping controller on the table.
- Battery power supply (2x 3 V CR 2032 batteries - included in the supply) with battery life of around 2 years based on frequency of use.
- Range up to 200 m (in open space), if the signal is insufficient between the controller and unit, use the signal repeater RFRP-20N or protocol component RFIO2 that support this feature.
- Attention: The controller is paired with the elements using the pairing button. Ord. codes for controllers with pairing button: RFGB-20/W Order No.: 8513, RFGB-20/B Order No.: 8512, RFGB-40/W Order No.: 8514, RFGB-40/B Order No.: 8488, see Pairing controllers on p. 84.

Device description

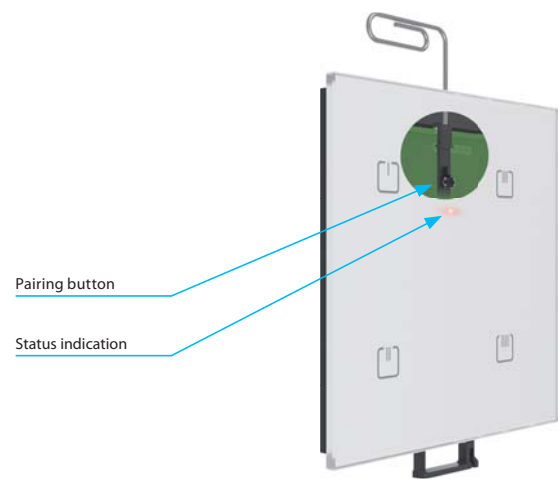
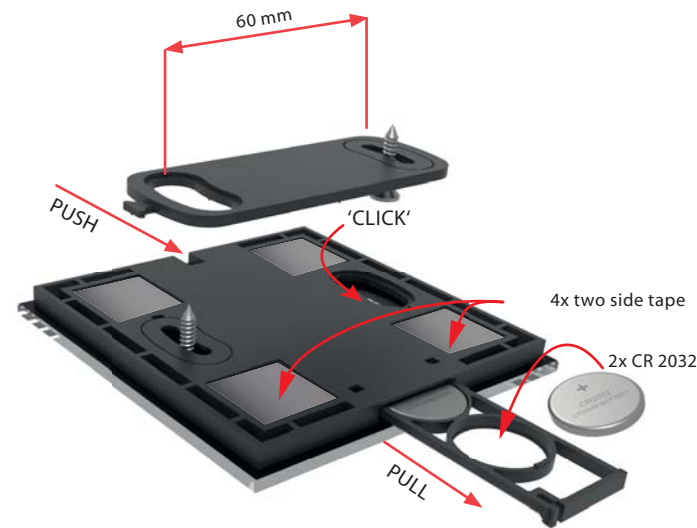
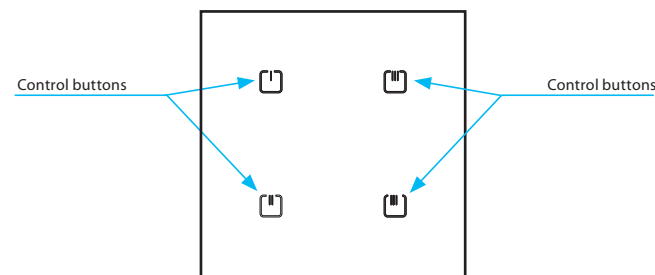

Variants

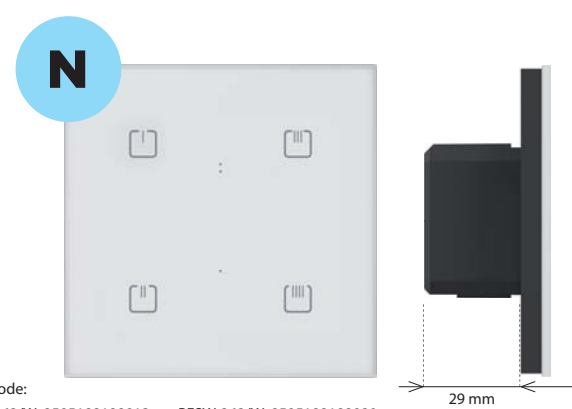
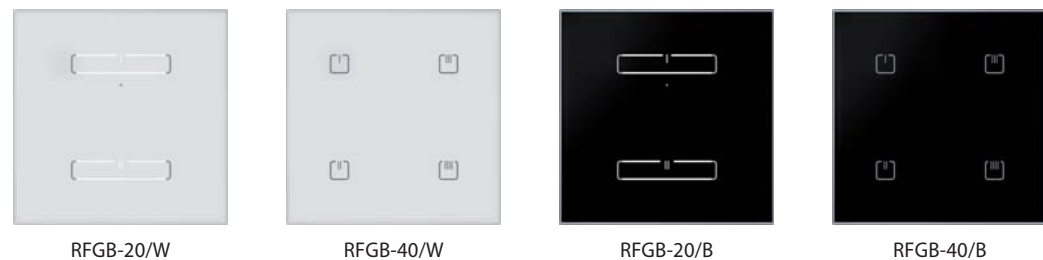

EAN code:
RFSW-62/W: 8595188188913 RFSW-262/W: 8595188188920
RFSW-62/B: 8595188188708 RFSW-262/B: 8595188188906

Technical parameters	RFSW-62/230V, RFSW-262/230V
Supply voltage:	230 V AC / 50-60 Hz
Apparent power:	1.1 VA
Dissipated power:	0.8 W
Supply voltage tolerance:	±10 %
Output	
Number of contacts:	2 switchingw
Breaking capacity:	8 A / AC1
Current rating:	2000 VA / AC1
Peak current:	10 A / <3 s
Switching voltage:	250 V AC1
Mechanical life:	1x10 ³
Electrical life (AC1):	1x10 ³
Control	
Wireless:	up to 25-channels (buttons)
Communication protocol:	RFIO2
Frequency:	866–922 MHz (for more information see p. 81)
Repeater function:	yes
Manual control:	4 touch keys, button PROG
Button backlight:	white LED with intensity change
Indications PROG:	red/green LED
Range:	in open space up to 160 m
Connection	
Terminals:	0.5 - 1 mm ²
Other data	
Operating temperature:	-10 to +50 °C
Storing temperature:	-30 to +70 °C
Protection degree:	IP20
Overvoltage category:	II.
Pollution degree:	2
Operation position:	any
Installation:	into installation box
Dimensions:	94 x 94 x 41 mm
Weight:	148 g
Related standards:	EN 60730, EN 63044, EN 301489, EN 300 220

- The glass design controller with two output relays is used to control appliances and lights.
- The touch buttons on the circuit breaker allow you to directly control the output relay as well as other components of the installation.
- The backlight intensity (white LED) of the buttons is automatically adjusted depending on the ambient lighting.
- They can be combined with detectors, controllers, iNELS Wireless or system components.
- 6 functions – button, impulse relay and time function of delayed start or return with a time setting of 2 s - 60 min. Any function can be assigned to each output relay. Function description can be found on p. 82.
- Possibility to set the memory of the output state during a power failure and subsequent restoration of the power supply.
- Each of the outputs can be controlled by up to 12/12 channels (1 channel represents one button on the controller).
- Range up to 160 m (in open space), if the signal is insufficient between the controller and unit, use the signal repeater RFRP-20N or protocol component RFIO2 that support this feature.
- Communication frequency with bidirectional protocol RFIO2.
- Pairing controllers on p. 84.

Colour variants

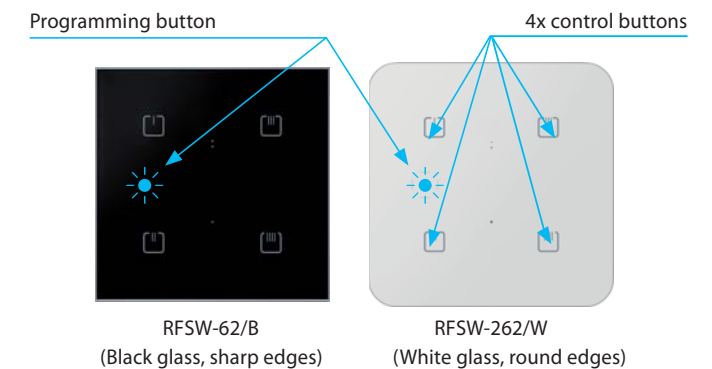

Connection

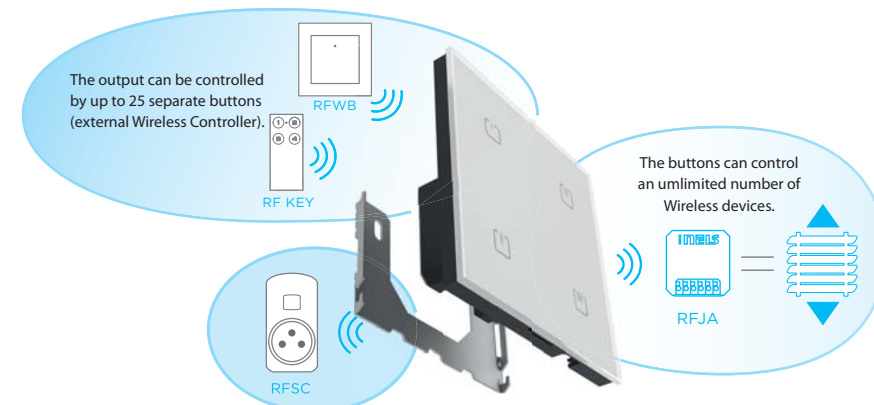
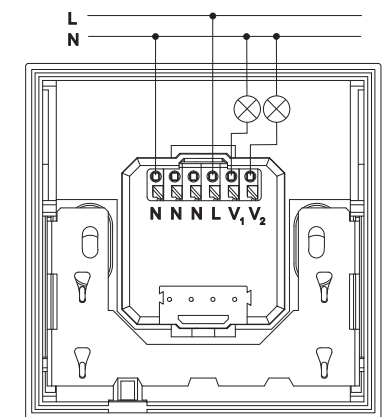

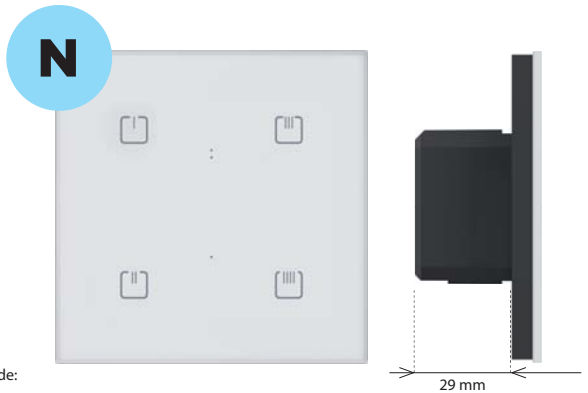

EAN code:
 RFDW-71/W: 8595188188944 RFDW-271/W: 8595188188951
 RFDW-71/B: 8595188188241 RFDW-271/B: 8595188188937

Technical parameters RFDW-71/230V, RFDW-271/230V	
Supply voltage:	230 V AC / 50-60 Hz
Apparent power:	1.1 VA
Dissipated power:	0.8 W
Supply voltage tolerance:	±10 %
Dimmed load:	R,L,C, LED, ESL
Output	
Contactless:	2 x MOSFET
Load capacity*:	max. 160 W
Control	
Wireless:	up to 25-channels (buttons)
Communication protocol:	RFIO2
Frequency:	866-922 MHz (for more information see p. 81)
Repeater function:	yes
Manual control:	4 touch keys, button PROG
Button backlight:	white LED with intensity change
Indications PROG:	red/green LED
Range:	in open space up to 160 m
Connection	
Max. cable size (mm2):	screwless clamps 0.2 - 1.5 mm ² solid/flexible
Other data	
Operating temperature:	-10 to +40 °C
Storing temperature:	-30 to +70 °C
Protection degree:	IP20
Overvoltage category:	II.
Pollution degree:	2
Operation position:	any
Installation:	into installation box
Dimensions:	94 x 94 x 41 mm
Weight:	129 g
Related standards:	EN 60730, EN 63044, EN 301489, EN 300 220

* See page 75 for the load chart for each light source.

- The glass design controller with dimmer and touch buttons is used to control light sources:
 - R – classic lamps (resistive load)
 - L – halogen lamps with wound transformer (inductive load)
 - C – halogen lamps with electronic transformer (capacity load)
 - ESL – dimmable energy-efficient fluorescent lamps
 - LED – LED light sources (230 V) equipped with LED.
- The touch buttons on the circuit breaker allow you to directly control the integrated dimmer as well as other components of the installation.
- The backlight intensity (white LED) of the buttons is automatically adjusted depending on the ambient lighting.
- They can be combined with detectors, controllers, iNELS Wireless or system components for output control from other locations.
- 7 light functions – smooth increase or decrease with time setting 2 s – 30 min. Function description can be found on p. 82.
- When switched off, the set level is stored in the memory, and when switched back on, it returns to the most recently set value.
- Thanks to setting the min. brightness you will eliminate flashing of the LED and ESL light sources.
- The universal dimmer may be controlled by up to 25-channels.
- Possibility to set the memory status in case of power failure.
- Range up to 160 m (in open space), if the signal is insufficient between the controller and unit, use the signal repeater RFRP-20N or protocol component RFIO2 that support this feature.
- Communication frequency with bidirectional protocol RFIO2.
- Pairing controllers on p. 84.

Colour variants

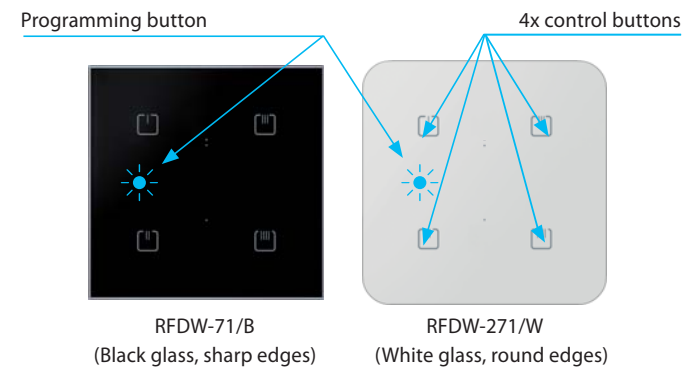

Connection

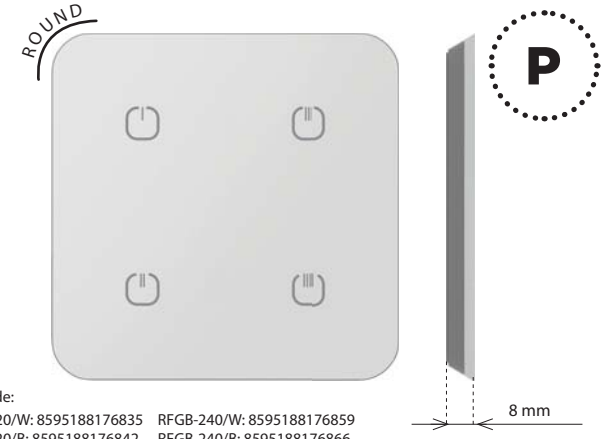
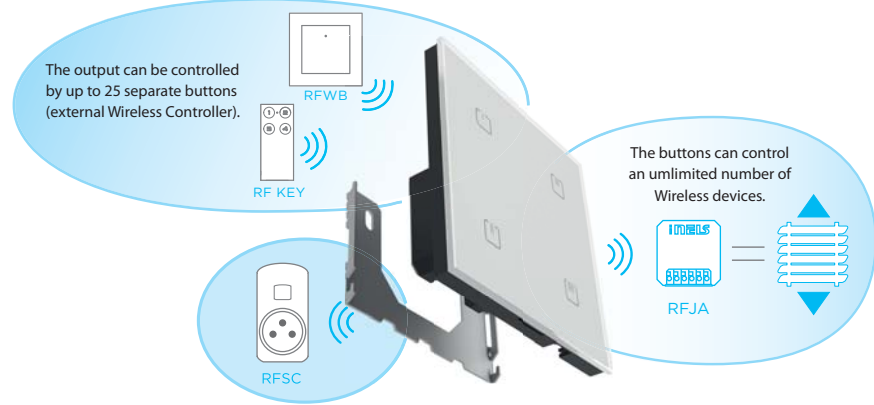
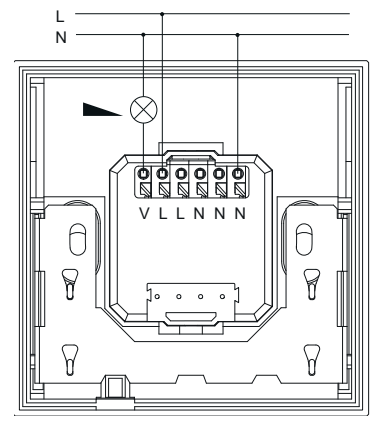

EAN code:
 RFGB-220/W: 8595188176835 RFGB-240/W: 8595188176859
 RFGB-220/B: 8595188176842 RFGB-240/B: 8595188176866

Technical parameters		RFGB-220	RFGB-240
Supply voltage:	2x 3 V CR 2032 batteries		
Battery life:	around 2 years based on frequency of use		
Transmission indication:	red LED		
Number of capacitive buttons:	2	4	
Communication protocol:	RFIO		
Frequency:	866-922 MHz (for more information see p. 81)		
Signal transmission method:	unidirectionally addressed message		
Range:	in open space up to 200 m		
Other data			
Operating temperature:	-10 to +50 °C		
Operating position:	any		
Mounting:	glue/screws		
Protection:	IP20		
Contamination degree:	2		
Dimensions:	100 x 100 x 8 mm		
Weight:	108 g	108 g	
Related standards:	EN 60730, EN 63044, EN 300 220, EN 301 489		

- The glass touch controller is a design iNELS Wireless unit and is available in elegant black and white variants.
- Only 8 mm thick.
- RFGB-220: 2 capacitive buttons allows to control 2 devices.
- RFGB-240: 4 capacitive buttons allows to control 4 devices.
- When pressing the button, it sends a set signal (ON/OFF, dimming, time switching OFF/ON, blinds up/down). Sending a command is indicated by a red LED.
- Option of setting light scenes, where with a single press, you can control units of iNELS Wireless.
- The rear base allows to be attached to installation using screws, double-sided tape or keeping controller on the table.
- Battery power supply (2x 3 V CR 2032 batteries - included in the supply) with battery life of around 2 years based on frequency of use.
- Range up to 200 m (in open space), if the signal is insufficient between the controller and unit, use the signal repeater RFRP-20N or protocol component RFIO2 that support this feature.
- Attention: The controller is paired with the elements using the pairing button. Ord. codes for controllers with pairing button: RFGB-220/W Order No.: 8517, RFGB-220/B Order No.: 8518, RFGB-240/W Order No.: 8515, RFGB-240/B Order No.: 8516, see Pairing controllers on p. 84.

Device description

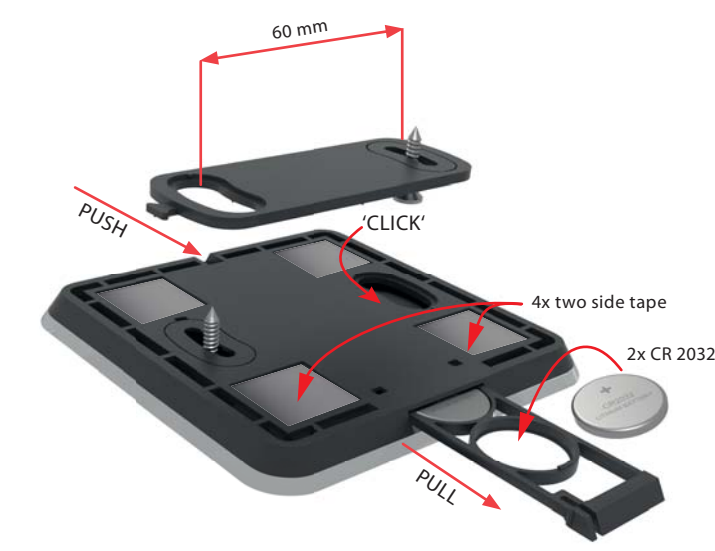
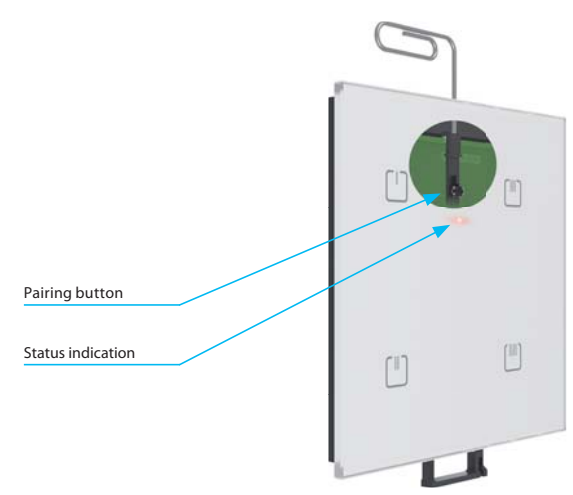
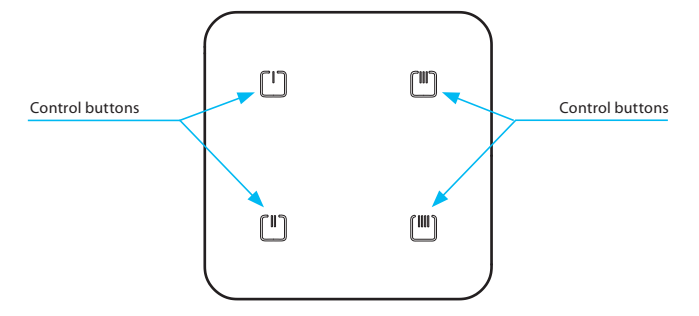

Variants





- The Remote Wireless controller with display is a central controller for switching electrical appliances and equipment, dimming lights, controlling blinds, etc.
- Designed in white and anthracite with colour OLED display.
- 4 directional joystick + 2 buttons for intuitive operation.
- Option of setting light scenes, where with a single press, you can control up to 10 units at once.
- Display of room temperature, battery status, date and time directly on display.
- The Favorites mode lets you preset the most frequently used devices on the home screen.
- Bidirectional communication, transmits and receives commands and displays the status of units.
- Thanks to the function of measuring the signal between the controller and unit, you can use it for testing the range and signal quality.
- Battery power (2x 1.5 V AAA batteries - included in supply) with battery life of around 3 years based on frequency of use and type of batteries.
- Range up to 200 m (in open space), if the signal is insufficient between the controller and unit, use the signal repeater RFRP-20N or protocol component RFIO2 that support this feature.

Device description

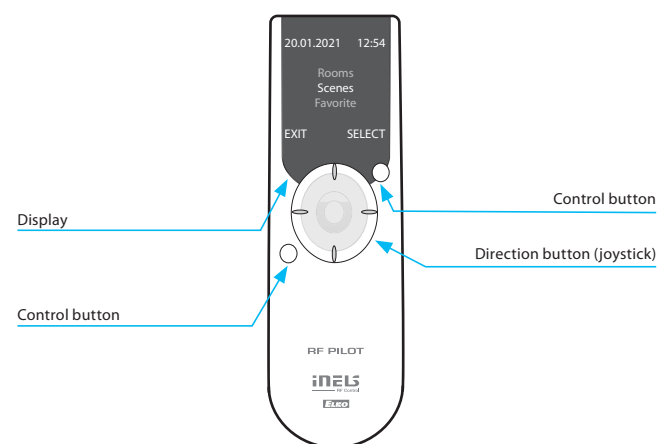

Display description

Colour LED display

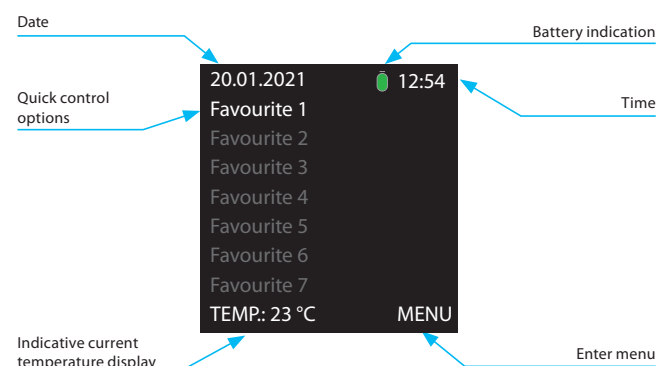

Technical parameters	RF Pilot/W	RF Pilot/A
Display		
Type:	colour OLED	
Resolution:	128 x 128 pixels	
Side ratio:	1:1	
Visible surface:	26 x 26 mm	
Backlighting:	self-illuminating text	
Diagonal:	1.5"	
Control:	direction button, control buttons	
Power supply		
Power supply:	2 x 1.5 V AAA batteries/R03	
Battery life:	approx. 3 years, according to the frequency of use and battery type	
Control		
Range:	in open space up to 200 m	
Communication protocol:	RFIO	
Frequency:	866–922 MHz (for more information see p. 81)	
Other data		
Operating temperature:	0 to +55 °C	
Storage temperature:	-20 to +70 °C	
Colour design:	white	anthracite
Protection:	IP20	
Operating position:	any	
Dimensions:	130 x 41 x 18 mm	
Weight:	61 g	
Related standards:	EN 60730, EN 63044, EN 300 220, EN 301 489	

RF Pilot

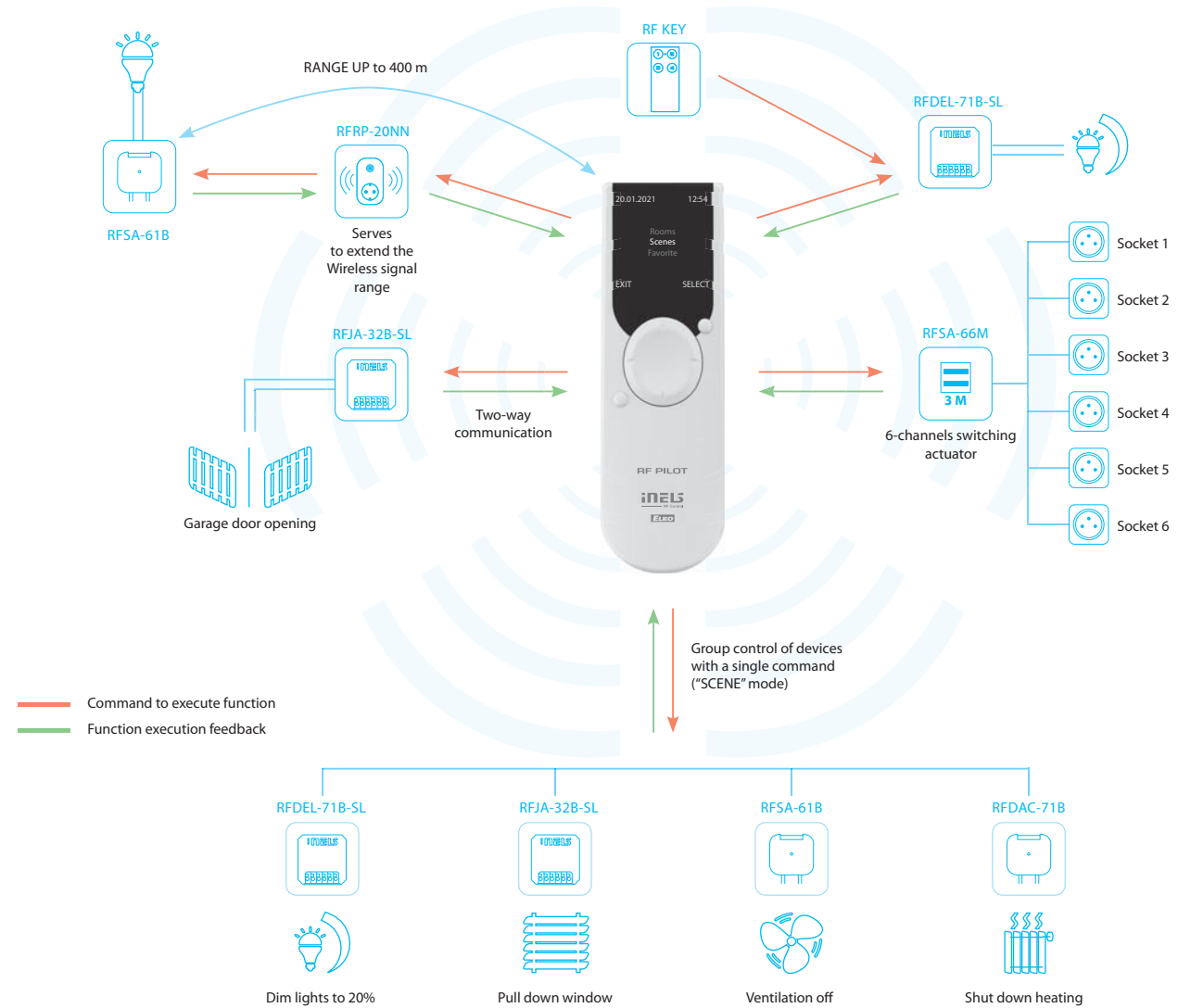

SCENES

- serves to control actuators as a group with a single touch
- possibility to set up scenes; on activation, for example, window shutters are pulled down and the light will adjust to the required brightness

WINDOW SHUTTERS

- controlling window shutters, blinds, garage door, etc.
- window shutters are controlled separately or as a group
- the window shutter receivers are powered by either 230 V or 24 V DC (shutters between windows)

FAVOURITE

- serves to select the most frequently used devices
- on display activation, the "Favourite" menu pops up automatically to provide you with a quick access to controlling devices

SWITCHING

- this function serves to switch on/off lights, sockets, electrical appliances and devices
- intuitive control thanks to customized name options
- switching actuator function selections: switch on/off, impulse relay, button, delayed ON/OFF (time of delay from 2 seconds to 60 minutes)
- function description can be found on p. 82

DIMMING

- the regulation of light intensity (light bulbs, LED strips, halogen lights with electrical or coil transformer, fluorescent tubes with dimmable ballast 1–10 V)
- customizable names of individual dimmed circuits (such as "lights" or "living room")
- "sunrise/sunset" imitation - light gradually goes on or off during the preset period between 2 seconds and 30 minutes
- function description can be found on p. 82



EAN code:

RF KEY-40/W: 8595188180740 RF KEY-60/W: 8595188180764
RF KEY-40/B: 8595188180757 RF KEY-60/B: 8595188180771

Technical parameters	RF KEY-40	RF KEY-60
Supply voltage:	3 V CR 2032 battery	
Battery life:	around 5 years based on frequency of use	
Transmission indication:	red LED	
Number of buttons:	4	6
Communication protocol:	RFIO	
Transmitter frequency:	866–922 MHz (for more information see p. 81)	
Signal transmission method:	unidirectionally addressed message	
Range:	in open space up to 200 m	
Other data		
Operating temperature:	-10 to +50 °C	
Operating position:	any	
Colour design:	white, black	
Protection:	IP20	
Contamination degree:	2	
Dimensions:	64 x 25 x 10 mm	
Weight:	16 g	
Related standards:	EN 60730, EN 63044, EN 300 220, EN 301 489	

- Key fob – sized remote control, available in black and white.
- When pressing the button, it sends a set signal (ON/OFF, dimming, time switching OFF/ON, blinds up/down).
- **RF KEY-40**: four buttons enable control of four units independently.
- **RF KEY-60**: six buttons enable control of four units independently.
- Battery power supply (3 V CR 2032 battery - included in the supply) with battery life of around 5 years based on frequency of use.
- Attention: The controller is paired with the elements using the pairing button. Ord. codes for controllers with pairing button: RF KEY-40/W Order No.: 8504, RF KEY-40/B Order No.: 8503, RF KEY-60/W Order No.: 8505, RF KEY-60/B Order No.: 8490, see Pairing controllers on p. 84.

Device description

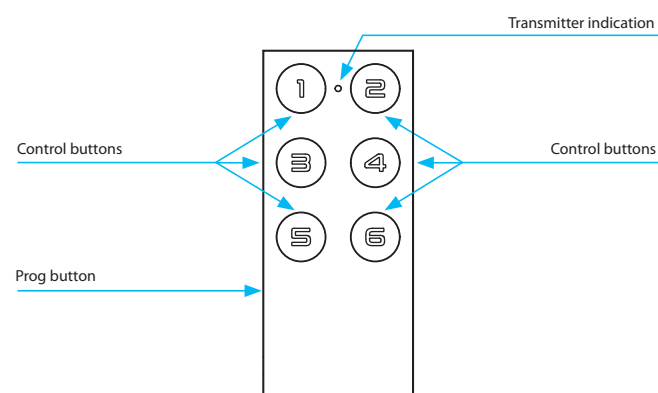

Variants



RF KEY-40/W

RF KEY-60/W

RF KEY-40/B

RF KEY-60/B

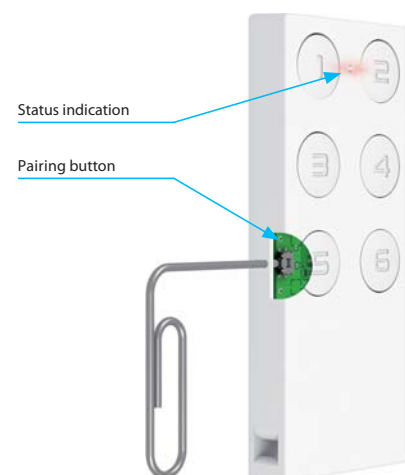

Status indication

Pairing button



EAN code:

RFSA-61B: 8595188136242

Technical parameters	RFSA-61B/230V
Supply voltage:	230 V AC
Supply voltage frequency:	50–60 Hz
Apparent input:	7 VA/cos φ= 0.1
Dissipated power:	0.7 W
Supply voltage tolerance:	+10 %; -15 %
Output	
Number of contacts:	1x NO, non potential
Rated current:	16 A/AC1
Switching power:	4000 VA/AC1, 384 W/DC
Peak current:	30 A/<3 s
Switching voltage:	250 V AC1/24 V DC
Max. DC switching power:	500 mW
Mechanical service life:	3x 10 ⁷
Electrical service life (AC1):	0.7x 10 ⁵
Control	
Wireless:	up to 25-channels (buttons)
Communication protocol:	RFIO2
Frequency:	866–922 MHz (for more information see p. 81)
Repeater function:	yes
Manual control:	button PROG (ON/OFF)
Range:	in open space up to 200 m
Other data	
Operating temperature:	-15 to +50 °C
Operating position:	any
Mounting:	free at lead-in wires
Protection:	IP30
Overvoltage category:	III.
Contamination degree:	2
Terminals (CY wire, cross-section):	2x 0.75 mm ² , 2x 2.5 mm ²
Length of terminals:	90 mm
Dimensions:	49 x 49 x 21 mm
Weight:	46 g
Related standards:	EN 60730, EN 63044, EN 300 220, EN 301 489

- The switching unit with 1 output channel 16 A is used to control appliances, lights (easy to integrate it to control garage doors or gates).
- They can be combined with detectors, controllers, iNELS Wireless or system components.
- **RFSA-61B**: multifunction design – button, impulse relay and time function of delayed ON or OFF with time setting of 2 s – 60 min. Function description can be found on p. 86.
- The switching unit may be controlled by up to 25-channels.
- The programming button on the unit is also used for manual control of the output.
- Memory status can be pre-set in the event of a power failure.
- Range up to 200 m (in open space), if the signal is insufficient between the controller and unit, use the signal repeater RFRP-20N or protocol component RFIO2 that support this feature.
- The BOX design lets you mount it right in an installation box, a ceiling or controlled appliance cover.

Device description

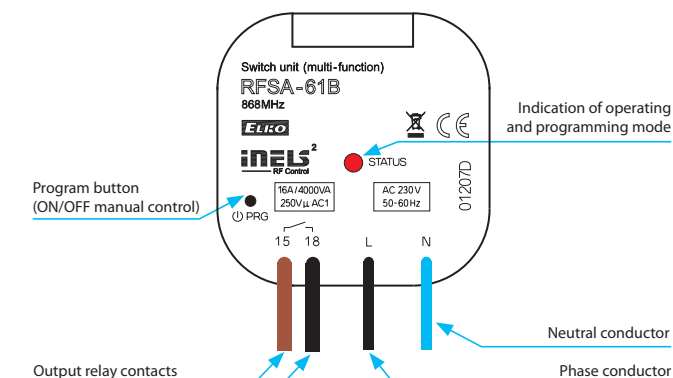

Connection

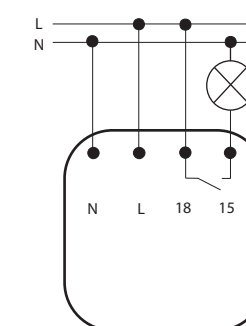

N

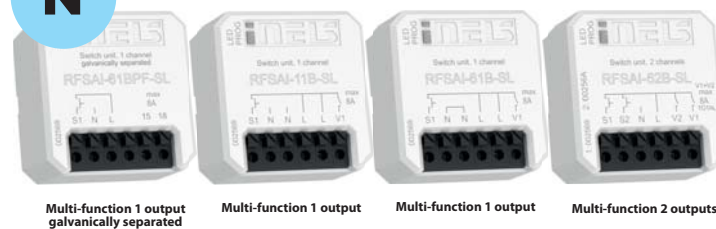

EAN code:
RFSAI-61BPF-SL: 8595188189101
RFSAI-11B-SL: 8595188183758
RFSAI-61B-SL: 8595188182041
RFSAI-62B-SL: 8595188182010

Technical parameters	RFSAI-61BPF-SL	RFSAI-11B-SL	RFSAI-61B-SL	RFSAI-62B-SL
Supply voltage:	230 V AC			
Supply voltage frequency:	50-60 Hz			
Apparent input:	7 VA / $\cos \varphi = 0.1$			
Dissipated power:	0.7 W			
Supply voltage tolerance:	+10 %; -15 %			
Output				
Number of contacts:	1x switching		2x switching	
Rated current:	8 A / AC1			
Switching power:	2000 VA / AC1			
Peak current:	I _{peak} < 110A 300us / max. input capacity 125 uF			
Switching voltage:	250 V AC1			
Mechanical service life:	1x10 ⁷			
Electrical service life (AC1):	1x10 ⁵			
Control				
Wireless:	25-channels		2x 12-channels	
Number of functions:	6	1	6	6
Communication protocol:	RFIO2			
Frequency:	866-922 MHz (for more information see p. 81)			
Repeater function:	yes			
Manual control:	button PROG (ON/OFF)			
External button / switch:	yes			
Range:	in open space up to 200 m			
Other data				
Operating temperature:	-15 to + 50 °C			
Operating position:	any			
Mounting:	free at lead-in wires			
Protection:	IP40			
Overvoltage category:	III.			
Contamination degree:	2			
Connection:	screwless terminals			
Connecting conductor:	0.2-1.5 mm ² solid/flexible			
Dimensions:	43 x 44 x 22 mm			
Weight:	31g		45 g	
Related standards:	EN 60730, EN 63044, EN 300 220, EN 301 489			

Function description

1. Button, impulse relay and time functions of delayed start or return with time setting 2 s-60 min. Any function can be assigned to each output relay.
2. The programming button on the element also serves as a manual input control.

- The switching component with one/two output relays is used to control appliances and lights. Switches/buttons connected to the wiring can be used for control.
- They can be combined with Detectors, Controllers or iNELS Wireless System Components.
- The BOX-SL version offers installation directly in the installation box, ceiling or cover of the controlled appliance. Easy installation thanks to screwless terminals.
- It allows the connection of switched loads with a total sum of 8 A (2,000 W).
- Switching element RFSAI-61BPF-SL has galvanically isolated terminals (potential-free contact)
- Functions: for RFSAI 61B-SL and RFSAI 62B-SL - pushbutton, impulse relay and time functions of delayed start or return with time setting 2 s-60 min. Any function can be assigned to each output relay. For RFSAI-11B-SL, the button has a fixed function - ON / OFF. Function description can be found on p. 86.
- The external button is assigned in the same way as the wireless one.
- Each of the outputs can be controlled by up to 12/12 channels (1-channel represents one button on the controller). Up to 25 channels for RFSAI-61B-SL and RFSAI-11B-SL.
- The programming button on the component also serves as a manual output control.
- Possibility to set the output status memory in case of failure and subsequent power recovery.
- The elements of the repeater can be set for the components via the RFAF / USB service device, PC, application.
- Range up to 200 m (outdoors), in case of insufficient signal between the controller and the device, use the RFRP-20N signal repeater or component with the RFIO2 protocol that support this function.
- Communication with bidirectional RFIO2 protocol.
- The contact material of the AgSnO₂ relay enables switching of light ballasts.

Device description

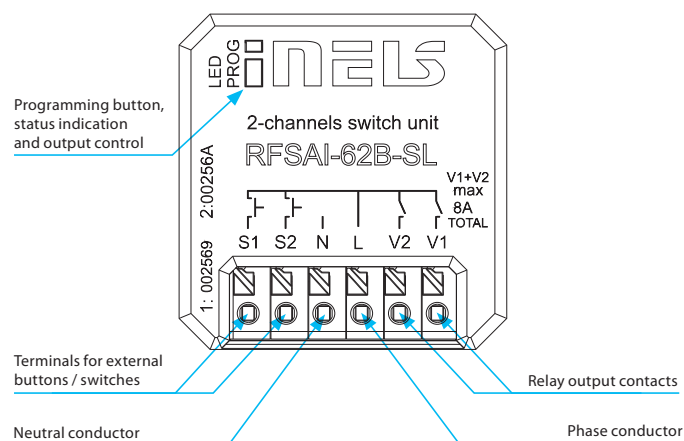

Connection

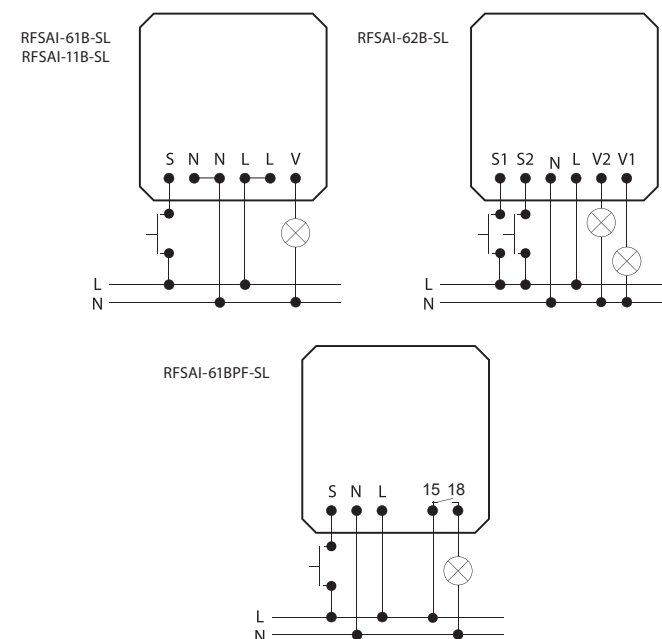

EAN code:
RFJA-32B-SL: 8595188182546

Technical parameters	RFJA-32B-SL
Supply voltage:	230 V AC
Supply voltage frequency:	50-60 Hz
Apparent input:	7 VA / $\cos \varphi = 0.1$
Dissipated power:	0.7 W
Supply voltage tolerance:	+10 %; -15 %
Output	
Number of contacts:	2x switching
Rated current:	8 A / AC1
Switching power:	2000 VA / AC1
Peak current:	10 A / < 3 s
Switching voltage:	250 V AC1
Mechanical service life:	1x10 ⁷
Electrical service life (AC1):	1x10 ⁵
Control	
Wireless:	25-channels
Communication protocol:	RFIO2
Frequency:	866-922 MHz (for more information see p. 81)
Repeater function:	yes
Manual control:	PROG (ON/OFF) button
External button / switch:	max. 100 m cable
Range:	in open space up to 200 m
Other data	
Operating temperature:	-15 to + 50 °C
Operating position:	any
Mounting:	free at lead-in wires
Protection:	IP30
Overvoltage category:	III.
Contamination degree:	2
Connecting conductor cross-section (mm ²):	0.2 - 1.5 mm ² solid / flexible
Dimensions:	43 x 44 x 22 mm
Weight:	45 g
Related standards:	EN 60730, EN 63044, EN 300 220, EN 301 489

- The switching unit for shutters has 2 output channels used to control garage doors, gates, blinds, awnings...
- They can be combined with Controllers or iNELS Wireless System Components.
- The BOX version offers mounting directly in the installation box, ceiling or motor drive cover.
- RFJA-32B-SL: connection of switched load 2x 8 A (2x 2000 W), with the possibility of connecting existing wire buttons.
- Short presses of the controller allow tilting of the slats, long pressing of the raise / lower moves the blinds to the end position.
- Each component can be controlled by up to 25 channels (1 channel represents one assigned controller).
- The programming button on the device also serves as a manual output control.
- For components, the repeater function can be set via the RFAF / USB service device.
- Range up to 200 m (outdoors), in case of insufficient signal between the controller and the device, use the RFRP-20N signal repeater or components with the RFIO2 protocol that support this function.
- The contact material of the AgSnO₂.

Device description

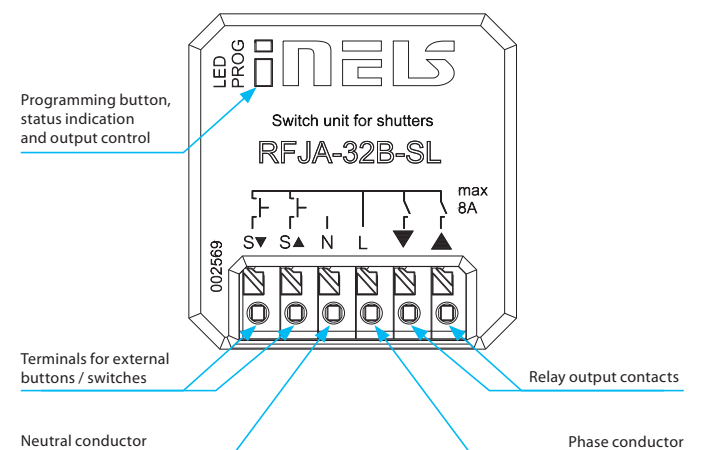

Function description

1. As long as the button on the remote control is pressed for < 2 s, the blinds move upwards (▲) or downwards (▼).
2. When the button is pressed for > 2 s, the blinds move upwards (▲) or downwards (▼) to the end position.

Connection

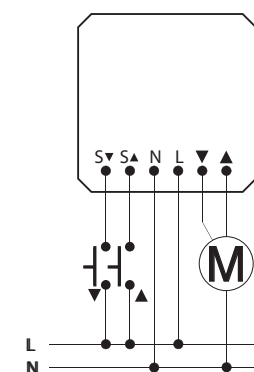



EAN code:
RFSA-61MI: 8595188181549
RFSA-61M: 8595188137003

Technical parameters	RFSA-61MI/230V	RFSA-61M/230V
Supply voltage:	110–230 V AC	
Supply voltage frequency:	50–60 Hz	
Apparent input:	2.7 VA $\cos \varphi=0.6$	
Dissipated power:	1.62 W	
Supply voltage tolerance:	+10%/-25 %	
Output		
Number of contacts:	1x changeover	
Rated current:	16 A/AC1	
Switching power:	4000 VA/AC1, 384 W/DC	
Peak current:	30 A/<3 s	
Switching voltage:	250 V AC1/24 V DC	
Contact material:	AgSnO ₂	
Mechanical service life:	3x10 ⁷	
Electrical service life (AC1):	0.7x10 ⁵	
Control		
Wireless:	up to 25-channels (buttons)	
Communication protocol:	RFIO2	
Frequency:	866–922 MHz (for more information see p. 81)	
Repeater function:	yes	
Manual control:	PROG (ON/OFF) button	
Range:	in open space up to 200 m	
Wireless Antenna:	integrated	external *
Other data		
Operating temperature:	-15 °C to +50 °C	
Operating position:	any	
Mounting:	DIN rail EN 60715	
Protection:	IP20 from the front panel	
Overvoltage category:	III.	
Contamination degree:	2	
Connecting conductor cross-section (mm ²):	max. 1x 2.5, max. 2x 1.5/ with a hollow max. 1x 2.5	
Dimensions:	90 x 17.6 x 64 mm	
Weight:	69 g	75 g
Related standards:	EN 60730, EN 63044, EN 300 220, EN 301 489	

* AN-I antenna (with SMA connector) is part of packaging.
Other antennas with cable are available on the p. 76.
Max tightening torque for antenna's connector is 0.56 Nm.

- **RFSA-61M:** the switching unit with 1 output channel 16 A is used for controlling appliances, sockets or lights.
 - the 1-MODULE design of the unit into a switchboard.
 - the switching unit may be controlled by up to 25-channels.
 - the package includes an internal antenna AN-I, in case of locating the element in a metal switchboard, you can use the external antenna AN-E for better signal reception, see accessories on p. 75.
- **RFSA-61MI:** same design and function as RFSA-61M, but with integrated antenna. It is suitable for placement in cabinets with plastic doors.
- 6 function: button, impulse relay and time function of delayed start or return with time setting range of 2 s – 60 min. Function description can be found on p. 76.
- The programming button on the unit is also used for manual control of the output.
- Memory status can be pre-set in the event of a power failure.

Device description

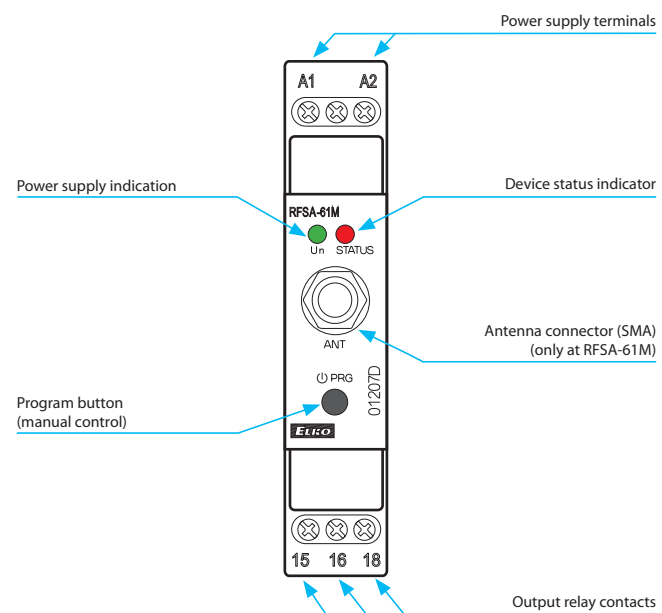

Connection

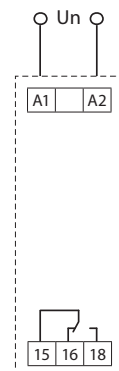

EAN code:
RFSA-66MI/230V: 8595188181556
RFSA-66MI/24V: 8595188181563
RFSA-66M/230V: 8595188137003
RFSA-66M/24V: 8595188152914

Technical parameters	RFSA-66MI/230V	RFSA-66MI/24V	RFSA-66M/230V	RFSA-66M/24V
Supply voltage:	110–230 V AC	12–24 V AC/DC	110–230 V AC	12–24 V AC/DC
SELV:	no	yes	no	yes
Supply voltage frequency:	AC 50–60 Hz			
Apparent input:	min. 2 VA/ max. 5 VA	-	min. 2 VA/ max. 5 VA	-
Dissipated power:	min. 0.5W/ max. 2.5W	max. 1.8 W	min. 0.5W/ max. 2.5W	max. 1.8 W
Supply voltage tolerance:	+10%/-15 %			
Output				
Number of contacts:	3x ECO, 3x NO			
Rated current:	8 A/AC1			
Switching power:	2000 VA/AC1			
Peak current:	10 A/<3 s			
Switching voltage:	250 V AC1			
Contact material:	AgSnO ₂			
Mechanical service life:	1x10 ⁷			
Electrical service life (AC1):	1x10 ⁵			
Control				
Wireless:	up to 25-channels (buttons)			
Communication protocol:	RFIO2			
Frequency:	866–922 MHz (for more information see p. 81)			
Repeater function:	yes			
Manual control:	PROG (ON/OFF) button			
Range:	in open space up to 200 m			
Wireless Antenna:	integrated		external *	
Other data				
Operating temperature:	-15 °C to +50 °C			
Operating position:	any			
Mounting:	DIN rail EN 60715			
Protection:	IP20 from the front panel			
Overvoltage category:	III.			
Contamination degree:	2			
Connecting conductor cross-section (mm ²):	max. 1x 2.5, max. 2x 1.5/ with a hollow max. 1x 2.5			
Dimensions:	90 x 52 x 65 mm			
Weight:	171 g		179 g	
Related standards:	EN 60730, EN 63044, EN 300 220, EN 301 489			

* AN-I antenna (with SMA connector) is part of packaging.
Other antennas with cable are available on the p. 81.
Max tightening torque for antenna's connector is 0.56 Nm.

- **RFSA-66M:** the switching unit with 6 output channels 8 A is used for independent control of up to 6 appliances, sockets or lights.
 - the 3-MODULE design of the unit into a switchboard.
 - each of the channels may be controlled by up to 25-channels.
 - the package includes an internal antenna AN-I, in case of locating the element in a metal switchboard, you can use the external antenna AN-E for better signal reception, see accessories on p. 76.
- **RFSA-66MI:** same design and function as RFSA-66M, but with integrated antenna. It is suitable for placement in cabinets with plastic doors.
- 6 function: button, impulse relay and time function of delayed start or return with time setting range of 2 s – 60 min. Function description can be found on p. 86.
- The programming button on the unit is also used for manual control of the output.
- Memory status can be pre-set in the event of a power failure.

Device description

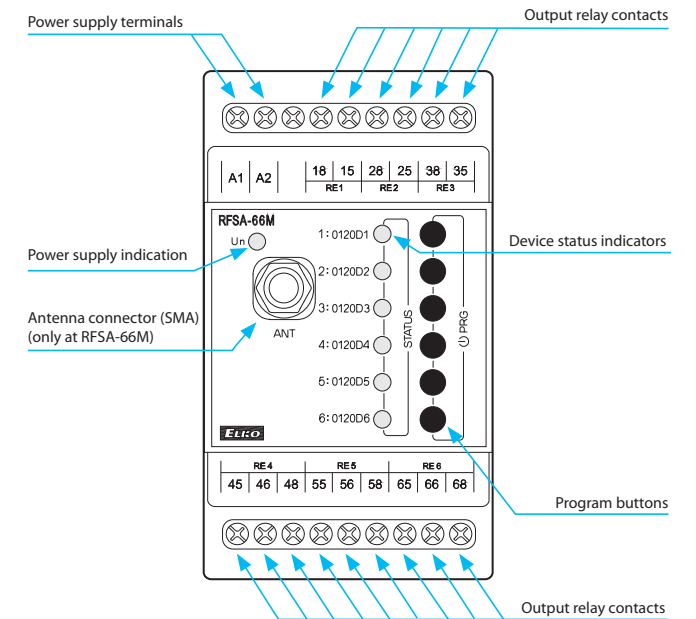

Connection

RFSA-66MI/230V
RFSA-66M/230V

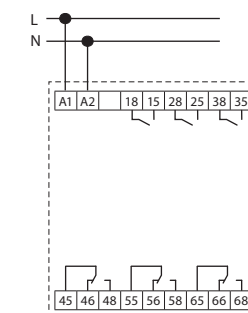

RFSA-66MI/24V
RFSA-66M/24V

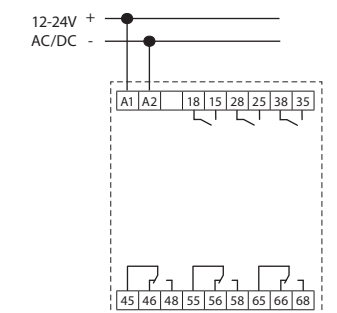



EAN code:
RFUS-61/230V: 8595188145268
RFUS-61/120V: 8595188152570

Technical parameters		RFUS-61/230V
Supply voltage:		230 V AC
Supply voltage frequency:		50–60 Hz
Apparent power:		5 VA/cos φ= 0.1
Dissipated power:		0.6 W
Supply voltage tolerance:		+10 %; -15 %
Output		
Rated current:		1x switching (AgSnO ₂)
Number of contacts:		12 A/AC1
Switching power:		3000 VA/AC1, 384 W/DC
Peak current:		30 A / <3 s
Switching voltage:		250 V AC1/24 V DC
Min. switching power DC:		500 mW
Mechanical service life:		3x10 ⁷
Electrical service life (AC1):		0.7x10 ⁵
Control		
Wireless:		up to 25-channels (buttons)
Communication protocol:		RFIO2
Frequency:		866–922 MHz (for more information see p. 81)
Repeater function:		yes
Manual control:		PROG (ON/OFF) button
Range:		in open space up to 200 m
Other data		
Operating temperature:		-15 to +50 °C
Operating position:		any
Mounting:		screws
Protection:		IP65
Overvoltage category:		III.
Contamination degree:		2
Cross-section of connecting wires (mm ²):		max. 1x 2.5, max. 2x 1.5/ with a hollow max. 1x 2.5
Recommended power cord:		CYKY 3x1.5 (CYKY 4x1.5)
Dimensions:		136 x 62 x 34 mm
Weight:		146 g
Related standards:		EN 60730, EN 63044, EN 300 220, EN 301 489

- The switching unit with 1x 12 A output channel is used for controlling appliances, sockets or lights.
- They can be combined with detectors, controllers, iNELS Wireless or system components.
- Multi-function design – button, impulse relay and time function of delayed ON or OFF with time setting of 2 s – 60 min. Function description can be found on p. 86.
- The switching unit may be controlled by up to 25-channels.
- The programming button on the unit is also used for manual control of the output.
- Range up to 200 m (in open space), if the signal is insufficient between the controller and unit, use the signal repeater RFRP20 or protocol component RFIO2 that support this feature.
- Communication frequency with bidirectional protocol RFIO2.

Device description

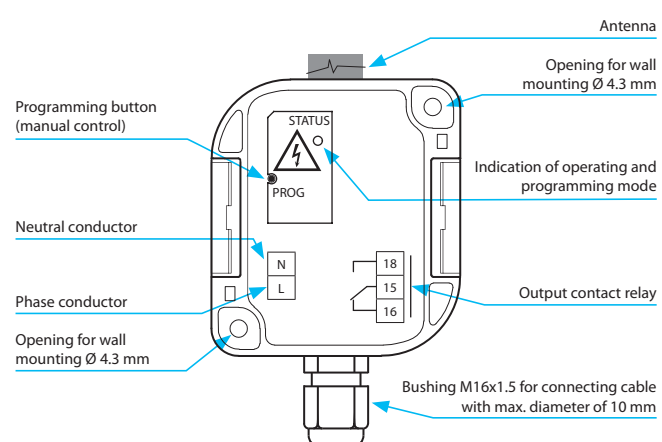

Connection

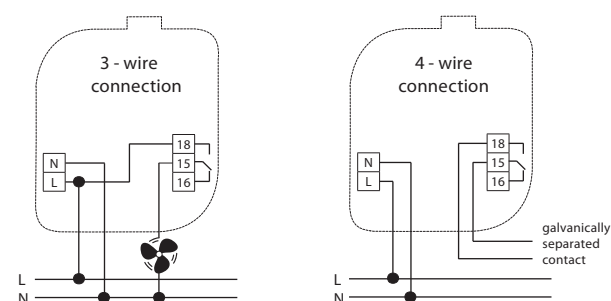

EAN code:
RFSC-61N/Schuko: 8595188182508 RFSC-61N/British: 8595188182522
RFSC-61N/French: 8595188182515

Technical parameters		RFSC-61N/230V
Supply voltage:		230 V AC
Supply voltage frequency:		50–60 Hz
Apparent power:		7 VA / cos φ = 0.1
Dissipated power:		0.7 W
Supply voltage tolerance:		+10 %; -15 %
Output		
Number of contacts:		1x switching
Rated current:		16 A / AC1
Switching power:		4000 VA / AC1
Peak current:		30 A / <3 s
Switching voltage:		250 V AC1
Min. switching power DC:		500 mW
Mechanical service life:		10x10 ⁶
Electrical service life (AC1):		0.7x10 ⁵
Control		
Wireless:		up to 32-channels (buttons)
Communication protocol:		RFIO2
Frequency:		866–922 MHz (for more information see p. 81)
Repeater function:		no
Manual control:		button PROG (ON/OFF)
Range:		in open space up to 200 m
Other data		
Operating temperature:		-15 to +50 °C
Working position:		any
Mounting:		plug into a socket
Protection:		IP30
Overvoltage category:		III.
Contamination degree:		2
Dimensions:		63 x 110 x 74 mm
Weight:		129 g
Related standards:		EN 60730, EN 63044, EN 300 220, EN 301 489

- The switched socket is used to control fans, lamps, direct heaters and appliances, which are connected by a power cord with a plug up to 16 A.
- They can be combined with detectors, controllers or iNELS Wireless system components.
- Multifunctional design - button, impulse relay and time functions of delayed start or return with time setting 2 s - 60 min. (see p. 86)
- The switched socket can be controlled by up to 32 channels.
- The programming button on the socket also serves as a manual output control with indication.
- Possibility to set the output status memory in case of failure and subsequent power recovery.
- Range up to 200 m (outdoors) (in case of insufficient signal between the controller and the device, use the RFRP-20N signal repeater) or components with the RFIO2 protocol that support this function.
- Thanks to the socket design, installation is simple and straightforward by plugging it into an existing socket.
- The contact material of the AgSnO₂ relay enables switching of light ballasts.

Produced in 3 designs of sockets/plugs:



Device description

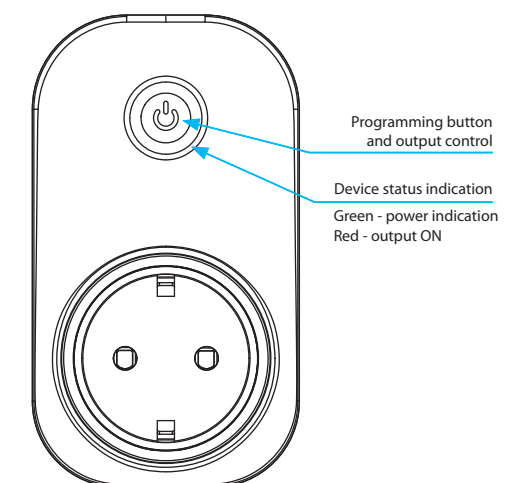



EAN code:
RFDAC-71B: 8595188182676

Technical parameters	RFDAC-71B
Supply voltage:	110–230 V AC
Supply voltage frequency:	50–60 Hz
Apparent input:	7 VA / $\cos \varphi = 0.1$
Dissipated power:	0.7 W
Supply voltage tolerance:	+10/-15 %
Control	
Potential-free analog output/max. current:	0(1)–10 V/10 mA
Rated current:	1x AgSnO ₂ switches the phase conductor
Rated current:	8 A/AC1
Switching power:	2 000 VA/AC1
Switching voltage:	250 V AC1
Mechanical service life:	3x10 ⁷
Electrical service life:	1x10 ⁵
Indication:	red LED/green LED
Output selection:	0(1)–10V/PROG button
Control	
Wireless:	up to 25-channels (buttons)
Communication protocol:	RFIO2
Frequency:	866–922 MHz (for more information see p. 81)
Repeater function:	yes
Manual control:	button PROG (ON/OFF)
Range:	in open space up to 200 m
Minimal control distance:	20 mm
Other data	
Operating temperature:	-15 to + 50 °C
Operating position:	any
Mounting:	plug into a socket
Protection:	IP40
Oversvoltage category:	III.
Contamination degree:	2
Terminals (CY wire, cross-section):	3 x 0.75 mm ² , 2 x 2.5 mm ²
Dimensions:	49 x 49 x 21 mm
Weight:	52 g
Related standards:	EN 60730, EN 63044, EN 300 220, EN 301 489

- The device with analog output 0(1)–10 V is used to control devices, luminaires, thermal actuators and thermal heads – which are equipped with such an input.
- They can be combined with detectors, controllers, iNELS Wireless or system components.
- Potential free analog output 0(1)–10 V, contact relay 8 A.
- 7 light functions – smooth increase or decrease with time setting 2 s–30 min. Function description can be found on p. 86.
- The analog controller may be controlled by up to 25-channels.
- The programming button on the controller is also used for manual control of the output.
- Memory status can be pre-set in the event of a power failure.
- Range up to 200 m (in open space), if the signal is insufficient between the controller and unit, use the signal repeater RFRP-20N or protocol component RFIO2 that support this feature.
- The BOX design lets you mount it right in an installation box, a ceiling or light cover.

Device description

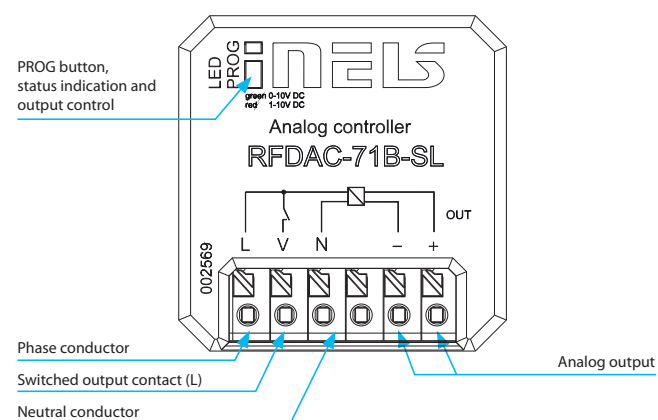

Connection

Connection example: dimming of fluorescent tubes with dimmable ballast

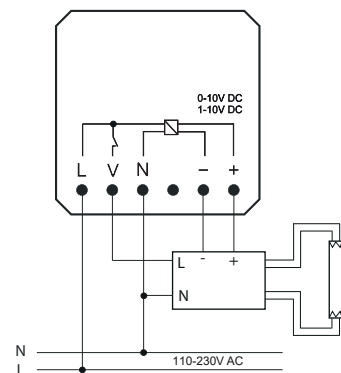

Connection example: with thermo valve

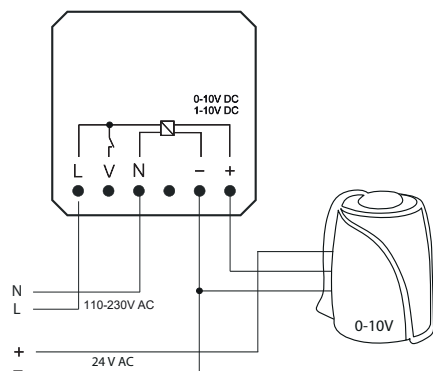

EAN code:
RFDEL-71B-SL: 8595188183611

Technical parameters	RFDEL-71B-SL/230V
Supply voltage:	230 V AC / 50 Hz
Supply voltage frequency:	50-60 Hz
Apparent power:	5 VA / $\cos \varphi = 0.1$
Dissipated power:	0.5 W
Supply voltage tolerance:	+10/-15 %
Connection:	4-wire, with "NEUTRAL"
Output	
Dimmed load:	R, L, C, LED, ESL
Contactless:	2 x MOSFET
Load capacity:*	max. 300 W*
Control	
Wireless:	up to 25-channels (buttons)
Communication protocol:	RFIO2
Frequency:	866-922 MHz (for more information see p. 81)
Repeater function:	yes
Range:	up to 200 m
Manual control:	tlačítko PROG (ON/OFF)
External button / switch:	yes
Other data	
Operating temperature:	-15 to + 45 °C
Working position:	any
Mounting:	free at lead-in wires
Protection:	IP40
Oversvoltage category:	III.
Contamination degree:	2
Connection:	screwless terminals
Connecting conductor:	0.2-1.5 mm ² solid/flexible
Dimensions:	43 x 44 x 22 mm
Weight:	30 g
Related standards:	EN 60730, EN 63044, EN 300 220, EN 301 489

- Universal built-in dimmer is used to regulate light sources:
 - R – classic light bulbs,
 - L – halogen bulbs with wound transformer,
 - C – halogen bulbs with electronic transformer,
 - ESL – dimmable energy saving lamps,
 - LED – LED light sources (230 V).
- They can be combined with Detectors, Controllers or iNELS Wireless System Elements.
- 7 light functions - smooth start or stop with time setting 2 s-30 min., function description p. 86.
- Min. brightness eliminates flickering LED and ESL light sources.
- The universal dimmer can be controlled by up to 25 channels
- Control input "S" for connecting an existing wired button.
- The programming button on the device also serves as a manual output control.
- Possibility to set memory status in case of power failure.
- The repeater function of the components can be set via the RFAF / USB service device.
- Range up to 200 m (outdoors), in case of insufficient signal between the controller and the component, use the RFRP-20N signal repeater or components with the RFIO2 protocol that support this function.
- The BOX version offers mounting directly in the installation box, ceiling or luminaire cover.

Device description

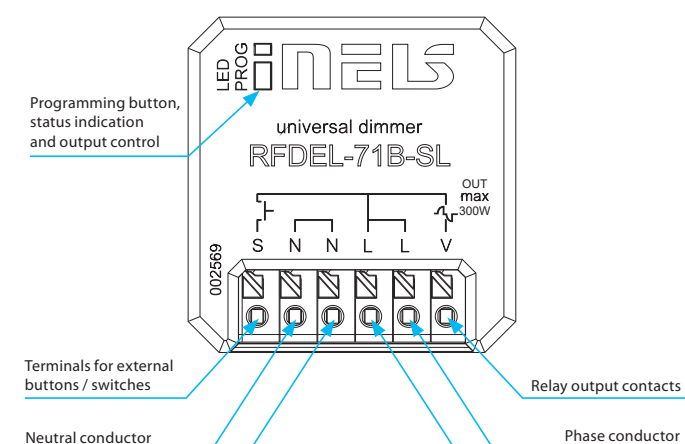

Connection

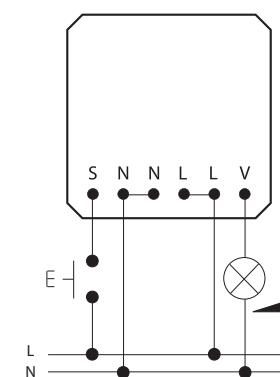

Types of connectable loads

R resistive	L inductive	C capacitive	LED light	ESL saving

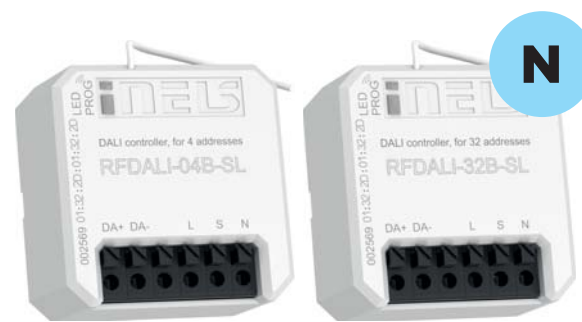

N

EAN code:
RFDALI-04B-SL: 8595188185271

RFDALI-32B-SL: 8595188184342

Technical parameters	RFDALI-04B-SL RFDALI-32B-SL
Supply voltage:	100-230 V AC / 50 Hz
Supply voltage frequency:	50/60 Hz
Apparent power:	5 VA / $\cos \varphi = 0.1$
Dissipated power:	3 W
Supply voltage tolerance:	+10/-15 %
Connection:	4-wire, L, N, DA+, DA-
Output DALI	
Number of devices:	max. 4 max. 32
Power supply:	16V/100 mA
Control	
Wireless:	32-channels
Communication protocol:	iNELS Wireless
Frequency:	866-922 MHz (for more information see p. 81)
Repeater function:	yes
Range:	up to 200 m
Manual control:	button PROG (ON/OFF)
External button / switch:	yes
Configuration	
Interface	WiFi AP 2.4 GHz, webserver
Application	Internet browser
Other data	
Operating temperature:	-15 to +50 °C
Working position:	any
Mounting:	free at lead-in wires
Protection:	IP40
Overvoltage category:	III.
Contamination degree:	2
Connection:	screwless terminals
Connecting conductor:	0.2-1.5 mm ² solid/flexible
Dimensions:	43 x 44 x 22 mm
Weight:	52g
Related standards:	EN 60730, EN 63044, EN 300 220, EN 301 489, EN 300 328

- The DALI controllers RFDALI-04B-SL and RFDALI-32B-SL are designed to control devices with a DALI interface, such as dimmers, electronic ballasts, LED converters and more.
- The control is performed by components from the iNELS Wireless system, detectors, controllers or system devices.
- Assignment and configuration of DALI devices is performed via webserver.
- The DALI bus is powered by the DALI controller.
- Control input "S" for connecting and controlling external buttons.
- The PROG button on the transmitter also serves as a manual output control.
- Possibility to set memory status in case of power failure.
- The repeater function of the components can be set via webserver.
- Range up to 200 m (outdoors), in case of insufficient signal between the controller and the device, use the RFRP-20N signal repeater or components with the RFIO2 protocol that support this function.
- The BOX version offers mounting directly in the installation box, ceiling or luminaire cover, screwless terminals for connection.

Device description

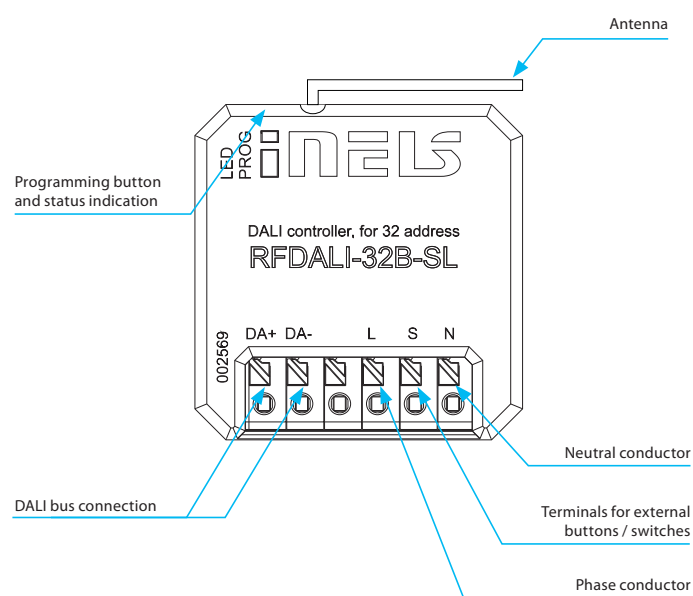

Connection

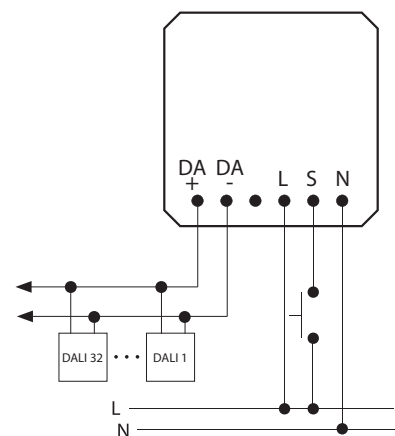

EAN code:
RFDEL-71M: 8595188148979

Technical parameters	RFDEL-71M/230V	RFDEL-71M/120V
Supply voltage:	230 V AC	120 V AC
Supply voltage frequency:	50 Hz	60 Hz
Apparent power:	2.5 VA	1.1 VA
Dissipated power:	0.8 W	0.6 W
Supply voltage tolerance:	+10/-15 %	
Output		
Dimmed load:	R, L, C, LED, ESL	
Contactless:	2 x MOSFET	
Load capacity:*	max. 600 W	max. 300 W*
Control		
Wireless:	up to 32 channels (buttons)	
Communication protocol:	RFIO2	
Frequency:	866-922 MHz (for more information see p. 81)	
Repeater function:	yes	
Range:	in open space up to 160 m	
Manual control:	SW (ON/OFF) button	
External button:	max. 50 m cable	
Glow lamps connection:	no	
Analog control:	potentiometer or 0 (1)-10 V	
Wireless Antenna:	AN-I included (SMA connector**)	
Other data		
Operating temperature:	-20 to +35 °C	
Storage temperature:	-30 to +70 °C	
Operating position:	vertical	
Mounting:	DIN rail EN 60715	
Protection:	IP20 under normal conditions	
Overvoltage category:	II.	
Contamination degree:	2	
Cross-section of connecting wires:	max. 1x 2.5, max. 2x 1.5/with a hollow max. 1x 2.5	
Dimensions:	90 x 52 x 65 mm	
Weight:	125 g	
Related standards:	EN 60730, EN 63044, EN 300 220, EN 301 489	

* See page 83 for the load chart for each light source.

** Max. Tightening Torque for antenna connector is 0.56 Nm.

- The universal modular dimmer is used to regulate light sources:
 - R – classic lamps (resistive load)
 - L – halogen lamps with wound transformer (inductive load)
 - C – halogen lamps with electronic transformer (capacity load)
 - ESL – dimmable energy-efficient fluorescent lamps
 - LED – LED light sources equipped with LED.
- Control can be performed by:
 - detectors, Controllers and System units iNELS Wireless
 - by control signal 0(1)-10 V
 - potentiometer
 - existing button in the installation.
- 6 light functions – smooth increase or decrease with time setting 2 s-30 min. Function description can be found on p. 86.
- Thanks to setting the min. brightness by potentiometer, you will eliminate flashing of the LED and ESL light sources.
- The universal dimmer may be controlled by up to 32-channels.
- The programming button on the controller is also used for manual control of the output.
- The package includes an internal antenna AN-I, in case of locating the unit in a metal switchboard, you can use the external antenna AN-E for better signal reception, see accessories on p. 76.
- Memory status can be pre-set in the event of a power failure.
- Range up to 160 m (in open space), if the signal is insufficient between the controller and unit, use the signal repeater RFRP-20N or protocol component RFIO2 that support this feature.
- The unit's 3-MODULE design with switchboard mounting.

Device description

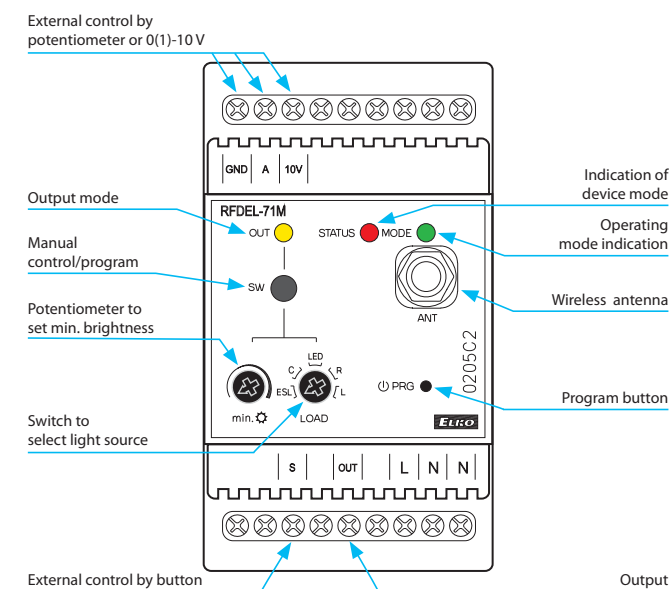

Connection and external control options

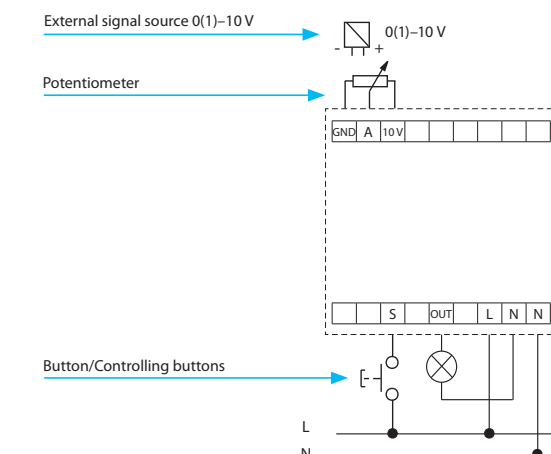



EAN code:

RFDEL-76M/230V: 8595188182058
RFDEL-76M/120V: 8595188182096

Technical parameters RFDEL-76M/230V RFDEL-76M/120V

Supply voltage:	230 V AC	120 V AC
Supply voltage frequency:	50 Hz	60 Hz
Power supply indication:	green LED Un	
Supply voltage tolerance:	+10/-15 %	

Output

Output:	12x MOSFET transistor	
Load type*:	R - resistive, L - inductive, C - capacitive, ESL - economical, LED	
Minimum output power:	10 VA	
Max. output power/channel:	150 VA	75 VA
Possible to connect outputs:	yes	
Maximum power when connecting all outputs:	max. 900 VA	max. 450 VA
Output protection:	thermal/short-term overload/longterm overload/short circuit	

Output indication:

red LED STATUS

Control

Input for buttons:	potential "L" or external voltage AC 20–230 V (50–60 Hz)/DC 20–230 V
Wireless:	up to 32-channels (with iNELS Wireless controllers)
Communication protocol:	RFIO2
Function repeater:	yes
Range:	in the open up to 160 m (524.11 ft)
Wireless antenna:	AN-I included (SMA connector)

Other information

Operating temperature:	-20 to +50 °C (-4 to 122 °F)
Storage temperature:	-30 to +70 °C (-22 to 158 °F)
Ingress protection:	IP20 under normal conditions
Overtoltage category:	II.
Contamination degree:	2
Connecting conductor:	max. 2.5 mm ² /1.5 mm ² with sleeve
Operating position:	vertical
Installation:	in the switchboard on DIN rail EN 60715
Design:	6-MODULE
Dimensions:	90 x 105 x 65 mm (3.5" x 4.1" x 2.6")
Weight:	320 g (11 oz.)
Related standards:	EN 60730, EN 63044, EN 301489, EN 300 220

*Warning: it is not allowed to simultaneously connect loads of inductive and capacitive type in the same channel.

Types of connectable loads

R resistive	L inductive	C capacitive	LED light	ESL saving

- RFDEL-76M is a universal 6-channels actuator, which is used to control the brightness intensity of dimmable sources R - L - C - LED - ESL.
- The maximum possible load is 150 VA for 230 V and 75 VA for 120 V for each channel.
- The individual channels of the dimmer can be connected in parallel and thus increase the maximum output load at the expense of the number of outputs.
- Each of the output channels is individually controllable and addressable.
- By setting the min. brightness eliminates flickering of different types of light sources, setting min. brightness and type of load is done using the PROG buttons.
- Electronic overcurrent, thermal and short-circuit protection, which switches off the output.
- 6 galvanically isolated inputs for wired buttons, which can be used to control the outputs independently of the iNELS Wireless.
- The package includes an internal AN-I antenna, in case of placement of a sheet metal distribution element, you can use an external AN-E antenna to improve the signal.

Description

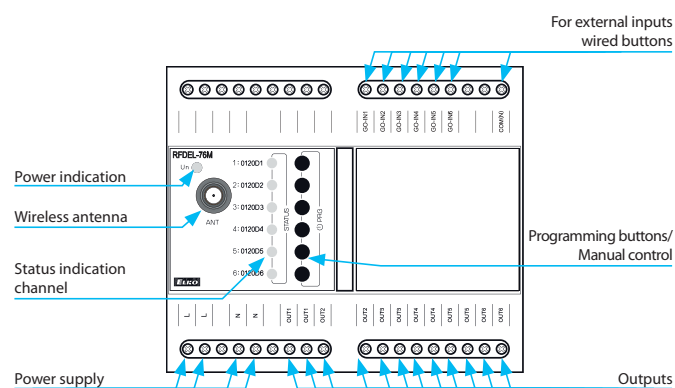

Connection

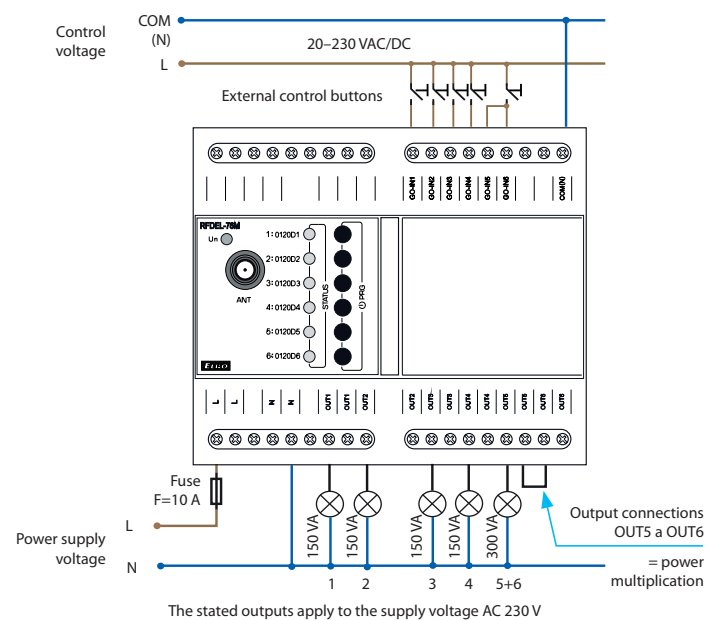

EAN code:

RFDA-73M/RGB: 8595188146814

Technical parameters RFDA-73M/RGB

Supply terminals:	Un+, GND
Supply voltage:	12–24 V DC stabilized
Maximum power without load:	0.8 W

Output

Dimmed load:	LED strip 12 V, 24 V with common anode RGB LED strips 12 V, 24 V with common anode
--------------	---

Number of channels:	3
Rated current:	3x5 A
Peak current:	3x10 A
Switching voltage:	Un

Control

Wireless:	up to 32-channels (buttons)
Communication protocol:	RFIO2
Frequency:	866–922 MHz (for more information see p. 81)
Repeater function:	yes
Load capacity of output +10 V:	10 mA
Ext. signal:	0–10 V, 1–10 V
Range:	in open space up to 160 m
Wireless Antenna:	AN-I included (SMA connector*)

Other data

Operating temperature:	-20 to +50 °C
Storage temperature:	-30 to +70 °C
Working position:	any
Mounting:	DIN rail EN 60715
Protection:	IP20 from front panel
Contamination degree:	2
Cross-section of connecting wires (mm ²):	max. 1x 2.5, max. 2x 1.5/ with a hollow max. 1x 2.5
Dimensions:	90 x 52 x 65 mm
Weight:	130 g
Related standards:	EN 60730, EN 63044, EN 300 220, EN 301 489

* Max Tightening Torque for antenna connector is 0.56 Nm.

- The dimmer for LED strips is used for independent control of 3 single-colour LED strips or one RGB LED strip.
- The expanded selection of control modes enables it to be combined with:
 - detectors, controllers and system units iNELS Wireless
 - device with output signal 0 (1)–10 V
 - potentiometer.
- The unit's 3-MODULE design with switchboard mounting enables connection of dimmed load 3x 5 A, which represents:
 - single-colour LED strip 7.2 W – 3x 8 m
 - RGB LED strip 14.2 W–10 m.
- 6 light functions – smooth increase or decrease with time setting 2 s – 30 min. Function description can be found on p. 86.
- The dimmer may be controlled by up to 32-channels.
- The power supply of the unit is in the range of 12–24 V DC, and is indicated by a green LED.
- The package includes an internal antenna AN-I, in case of locating the unit in a metal switchboard, you can use the external antenna AN-E for better signal reception, see accessories on p. 76.
- Memory status can be pre-set in the event of a power failure.
- Range up to 160 m (in open space), if the signal is insufficient between the controller and unit, use the signal repeater RFRP-20N or protocol component RFIO2 that support this feature.

Device description

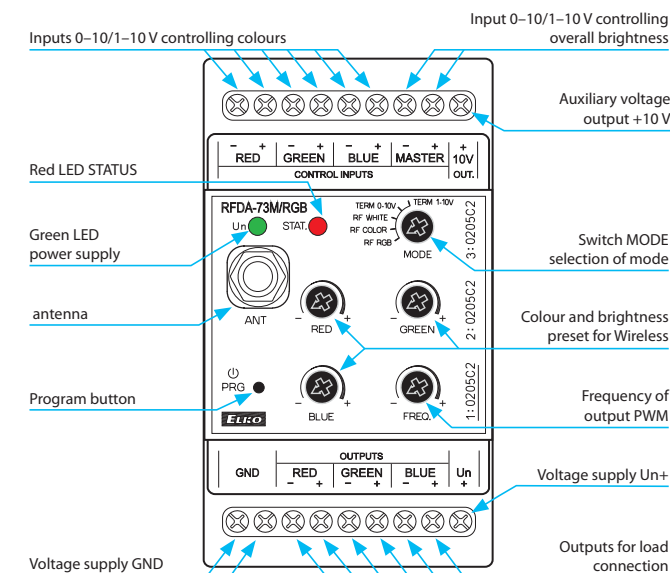

Output variations and external control options

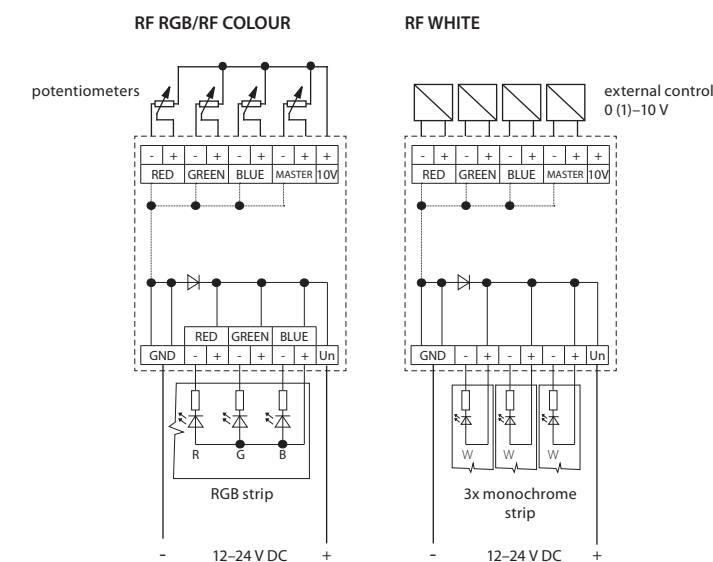

Control modes

RF RGB

Switch settings in MODE:

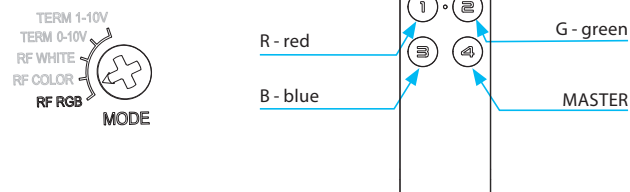

RF RGB mode for controlling RGB LED strips. In the RF RGB programming mode, colours are automatically assigned to individual transmitter buttons.

Note: The mode can be controlled by RF Touch, RF Pilot, RFWB-40/G, RF KEY, and eLAN-RF.

RF WHITE

Switch settings in MODE:

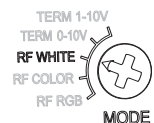

This works in a mode where it acts like three independent dimmers for 12-24 V. Each channel can be programmed independently of one another and has its own address.

Note: The mode can be controlled by RF Touch, RF Pilot, RFWB-20/G, RFWB-40/G, RF KEY and eLAN-RF.

RF Color

Switch settings in MODE:

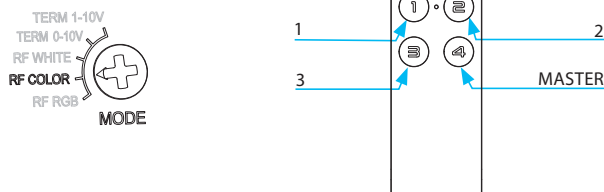

RF COLOUR mode for controlling RGB LED strips, where you can choose the colour for individual transmitter buttons. A long press of the button starts the colour search mode. After releasing the button, the current colour is set for the given button.

Note: The mode can be controlled by RF Touch, RF Pilot, RFWB-40/G, RF KEY, and eLAN-RF.

TERM 0-10 V and TERM 1-10 V

Switch settings in MODE:



Modes TERM 0-10 V and TERM 1-10 V. Inputs 0-10 V and 1-10 V used to control one RGB LED strip or three independent single-colour LED strips (see modes above) from the iNELS BUS System. For controlling, you can use the application iHC for smartphones and tablets.

Control options

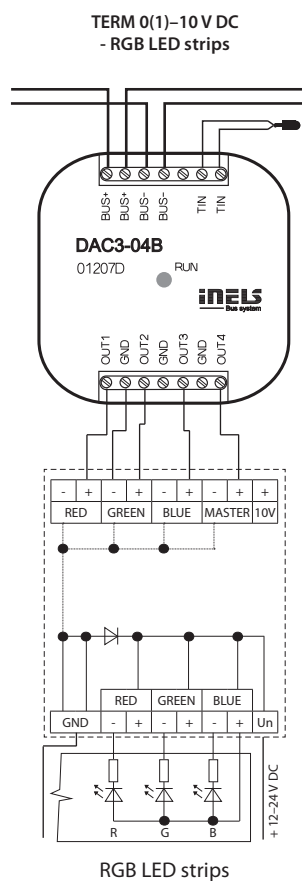
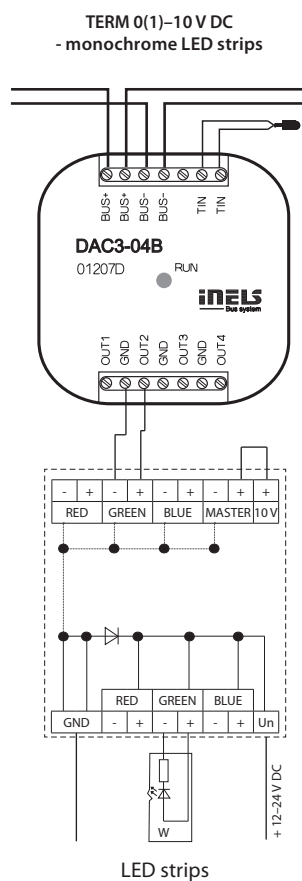

EAN code:
RFDSC-71N/Schuko: 8595188183604 RFDSC-71N/British: 8595188183581
RFDSC-71N/French: 8595188183598

Technical parameters	RFDSC-71N/230V
Supply voltage:	230 V
Supply voltage frequency:	50-60 Hz
Apparent power:	1.1 VA
Dissipated power:	0.8 W
Supply voltage tolerance:	+10/-15 %
Output	
Contactless:	2 x MOSFET
Load capacity*:	max. 200 W
Dimming load:	R, L, C, LED, ESL
Control	
Wireless:	up to 32-channels (buttons)
Communication protocol:	RFIO2
Frequency:	866-922 MHz (for more information see p. 81)
Repeater function:	no
Range:	in open space up to 160 m
Manual control:	button PROG (ON/OFF)
Other data	
Operating temperature:	-20 to +35 °C
Storage temperature:	-30 to +70 °C
Working position:	any
Mounting:	plug into a socket
Protection:	IP30
Overvoltage category:	III.
Contamination degree:	2
Dimensions:	63 x 110 x 74 mm
Weight:	118 g
Related standards:	EN 60730, EN63044, EN 300 220, EN 301 489

- The dimmable socket is used to regulate the brightness of the luminaires, which are connected by a power cord with a plug:
 - R - classic light bulbs (resistive load)
 - L - halogen bulbs with wound transformer (inductive load)
 - C - halogen bulbs with electronic transformer (capacitive load)
 - ESL - dimmable energy saving lamps
 - LED - light sources equipped with LED
- Multifunction - 6 light functions - smooth start or stop with time setting 2 s - 30 min. Description of functions on p. 86.
- Min. brightness potentiometer eliminates flickering of LED and ESL light sources.
- The universal dimmer can be controlled by up to 32 channels.
- The programming button on the socket also serves as a manual output control.
- Possibility to set the output status memory in case of failure and subsequent power recovery.
- Range up to 160 m (outdoors), in case of insufficient signal between the controller and the device, use the RFRP-20N signal repeater or components with the RFIO2 protocol that support this function.



Device description

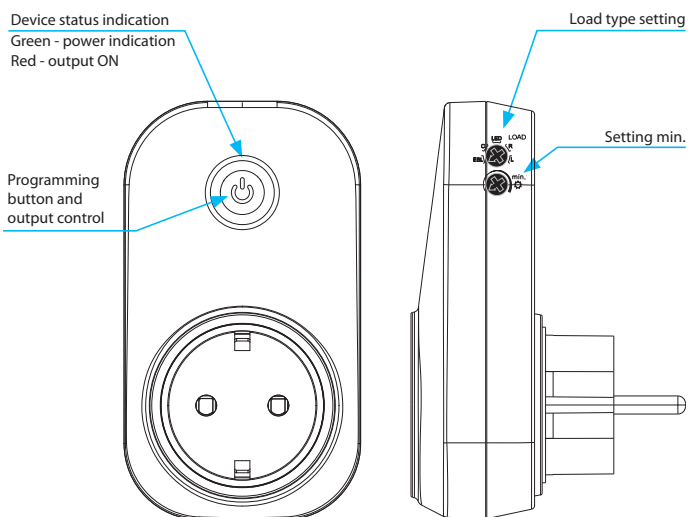

Types of loads

ESL	dimmable energy saving lamps
C	halogen bulbs with electronic transformer (capacitive load)
LED	LED light sources
R	classic light bulbs (resistive load)
L	halogen bulbs with wound transformer (inductive load)

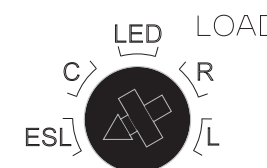



The picture of device is illustrative, the icons (symbols) are configurable by the customer.



- Designed to control 2 and 4 pipe fan coils, chillers
- 3x relays for fan speed (LOW, MEDIUM, HIGH), 2x relays for heating/cooling mode
- 2x analog outputs 0-10V for proportional control of valves
- 2x inputs for connecting wired detectors (door's magnet detector); of which
- 1x input for external temperature sensor TC/TZ
- Built-in digital temperature and humidity sensor
- Proximity sensor to activate display backlight / buttons
- VA/TN LCD display, 8 touch backlit buttons
- Screwless angle clamps for easy wire connection
- WiFi for device setup (via web browser) and connection to iNELS.Cloud, iNELS APP, HRS and BMS via MQTT protocol
- Modbus RTU for external HVAC devices and supervision software
- Power supply: AC 110 – 230V AC
- Installation on round (EU) and square (BS) boxes
- Possibility of the glass and icons customization icons.inels.com

Technical parameters	RFTC-3/W	RFTC-3/B
Power supply		
Power supply voltage:	110 - 230V AC, 50-60Hz, L and N terminals	
Apparent/loss power input:	4 VA/2 W	
Supply voltage tolerance:	± 10%	
Outputs		
Relays:	5x switching / 5A / 250V AC1 / 1385VA	
Contact life:	mechanical: 10 mil. / electrical 100.000 switches	
Analog Output:	2x 0-10V, 10 mA	
Inputs (external)		
Binary:	no potential-free contact, terminals IN1/IN2 against GND, maximum wire length 30m	
Temperature:	1x for external temperature sensor TC/TZ, terminals IN1/T & IN2/TC, temperature range -20 to +120 °C, accuracy ± 0.5 °C	
Sensors (internal)		
Temperature:	range 0 to +55 °C, accuracy ± 0.5 °C from the range	
Humidity:	0 - 99% RH, accuracy ± 3 °C from the range	
Proximity:	backlight activation when zooming <25 cm	
Lighting:	adaptive backlight control of the display and buttons	
Communications		
Radio:	iNELS RFIO2, frequency 866-922 Mhz	
WiFi:	AP 2.4 Ghz	
Modbus:	RTU 485	
Control and display		
Display:	LCD (VA/TN), active area 54x34mm	
Buttons:	8x, capacitive, backlit	
Functions		
Fancoil types:	2-pipe, 4-pipe	
Parameter settings:	via WiFi and web interface	
Connection		
Terminal block:	16 pole, screwless (push-in)	
Wire cross section:	0.2 - 1.5 mm² solid / flexible	
Mechanics		
Operating temperature:	- 0 to 50 °C / max 80% RH	
Storage Temperature:	- 20 to 60 °C	
Enclosure:	IP30 (mounted)	
Overvoltage Category:	II.	
Pollution Degree:	2	
Working position:	horizontal	
Installation:	on EU/BS box with 60 mm screw pitch	
Dimension:	120x80x27 mm	
Weight:	230g	
Shape:	SHARP edges	
Color (glass and plastic):	White	Black
Order Code:	8915	8914
EAN Code:	8595188189156	8595188189149
Standard:	EN 60730, EN 63044, EN 301489	

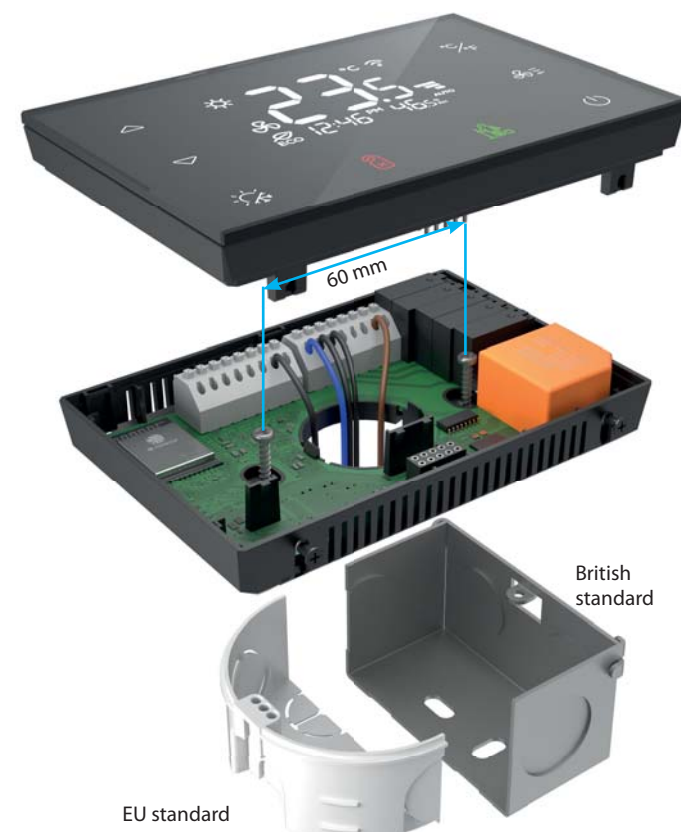

External temperature sensors:

	TC-0	TC-3	TC-6	TC-12
Length:	100 mm	3 m	6 m	12 m
Order code:	209970800010	209970800011	209970800012	209970800013



- Thermister: NTC 12K
- Protection: IP67
- Cable: 2 x 0.25 mm²
- Ending: cavity

Buttons description

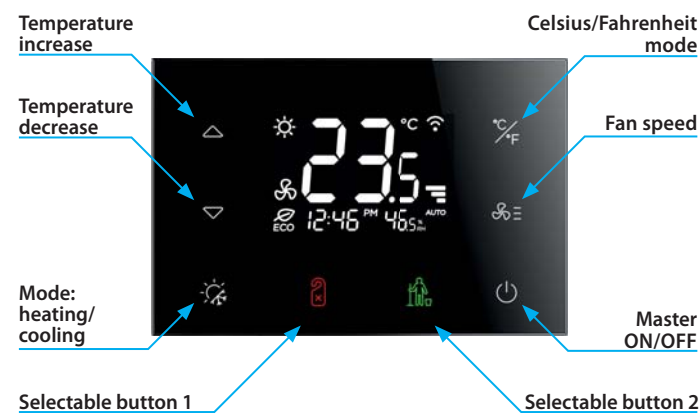

Display description

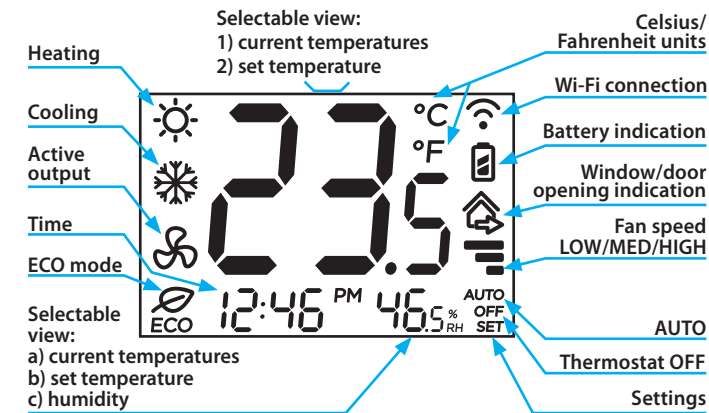

Connection

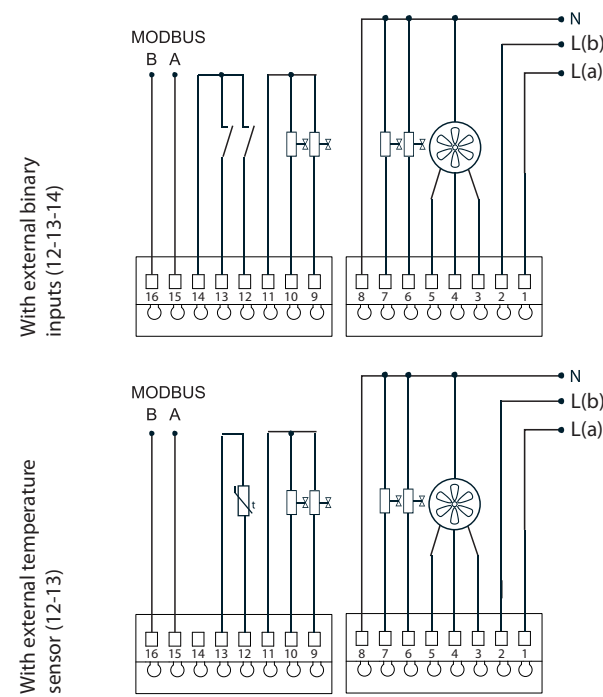

Clamp description

1. L(a) power supply phase wire
2. L(b) phase - identical to phase L(a) - see. *
3. HIGH fan top speed
4. MED fan medium speed
5. LOW fan lowest speed
6. HEAT valve 0/1 for heating
7. COOL valve 0/1 for cooling
8. N neutral wire power supply
9. 1:0-10V 1. analog output 0-10V
10. 2:0-10V 2. analog output 0-10V
11. GND common terminal for analog output
12. IN1 1. binary input for external contact
13. IN2 2. binary input for external contact
14. COM common terminal for binary inputs 1. and 2.
15. BUS A Modbus A
16. BUS B Modbus B

Option for an external temperature sensor TC/TZ

12. IN1 temperature input NTC
13. IN2 temperature input NTC

*in the case of an auxiliary heater, it is connected to terminals 6 or 7 (max. 1500 W).

Web configuration

Wi-Fi SSID : RFTC-3_product number IP address: 192.168.1.1

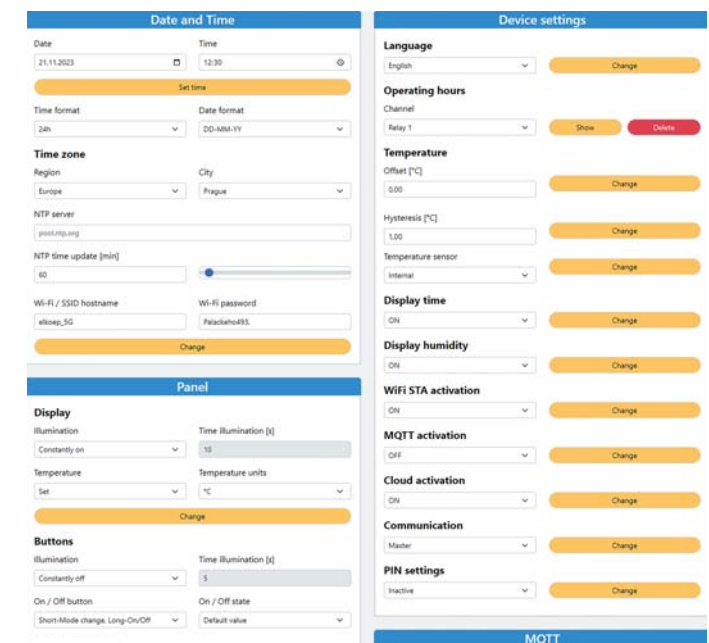

Variants



BLACK
RFTC-3/B
Order code: 8914
EAN: 8595188189149

WHITE
RFTC-3/W
Order code: 8915
EAN: 8595188189156



EAN code:
RFTC-10/G: 8595188145329

- RFTC-10/G is used for temperature measurement (in the range of 0 to 55 °C) and correction of the pre-set temperature in RF Touch or eLAN-Wireless system devices in the range of ± 5 °C. The temperature correction is valid until the next program change in the given system device.
- The backlit LCD display displays the current and set temperature, status (ON/OFF), battery status, etc.
- Range up to 100 m (in open space), if the signal is insufficient between the controller and unit, use the signal repeater RFRP-20N or protocol component RFIO2 that support this feature.
- Colour combination of heating unit in design of frames LOGUS⁹⁰ (plastic, glass, wood, metal, stone).

Technical parameters		RFTC-10/G
Supply voltage:	2 x 1.5 V AAA batteries	
Battery life:	1 year based on frequency of use	
Temperature correction:	2 buttons V/Λ	
Temperature offset:	± 5 °C	
Display:	LCD, characters/see Display description	
Backlighting:	active 10 s after pressing	
Transmission indication/function:	symbols	
Temperature measurement:	1x internal sensor	
Temp. measurement range and accuracy:	0 to +55 °C; 0.3 °C of the range	
Control		
Communication protocol:	RFIO	
Frequency:	866–922 MHz (for more information see p. 81)	
Repeater function:	no	
Signal transmission method:	bidirectionally addressed message	
Range:	in open space up to 100 m	
Minimum control distance:	20 mm	
Other data		
Max. number of control.	1	
RFSA-6x:	1	
Program:	x	
Operating temperature:	0 to +55 °C	
Operating position:	wall-mounted	
Mounting:	glue/screws	
Protection:	IP30	
Contamination degree:	2	
Dimensions frame		
- plastic:	85 x 85 x 20 mm	
- metal, glass, wood, granite:	94 x 94 x 20 mm	
Weight:	66 g (without batteries)	
Related standards:	EN 60730, EN 63044, EN 300 220, EN 301 489	

Compatibility				
RF Touch	eLAN-RF	RFSA-6x/RFSAI-6x	RFSTI-11B-SL	RFATV-2
✓	✓	✓	-	-

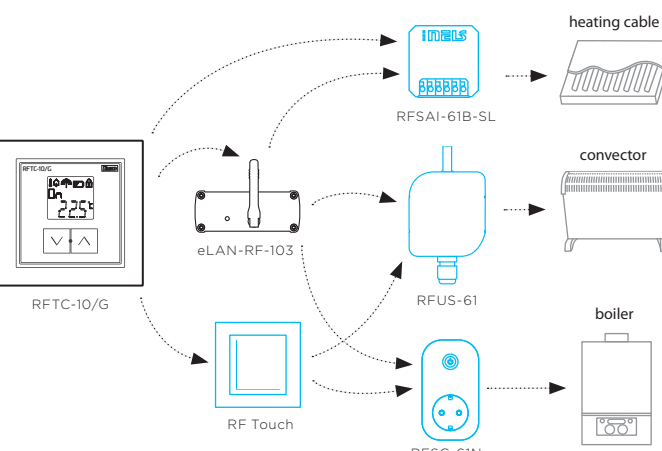
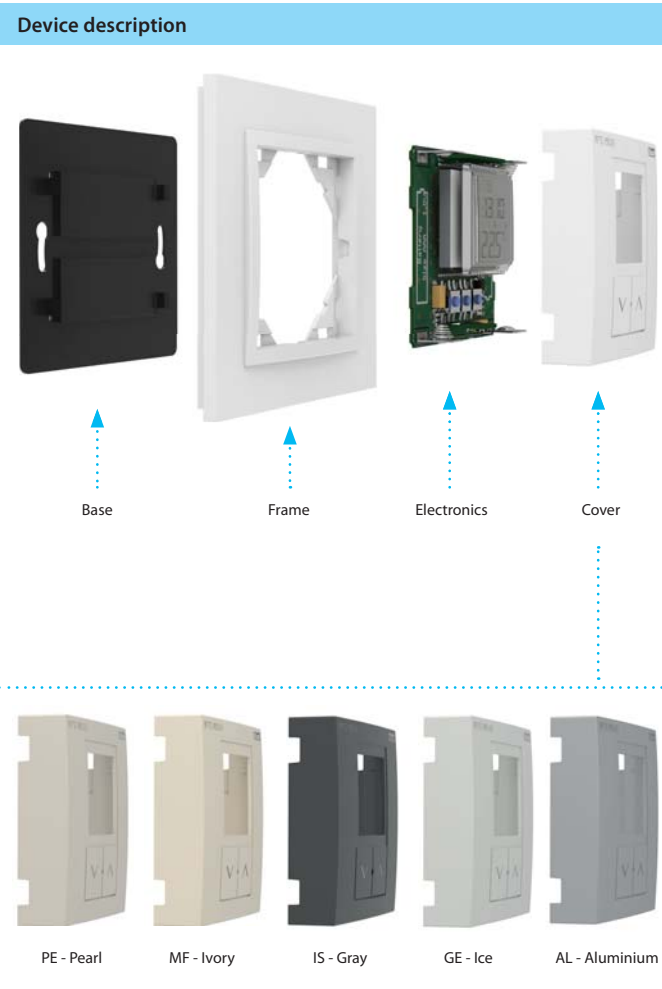
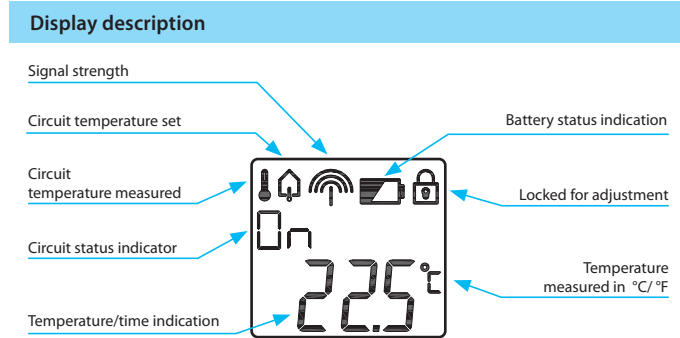

EAN code:
RFTC-50/G: 8595188148641

- RFTC-50/G is a separate thermostat that allows wireless control of up to 4 multifunctional switching components, e.g. RFSAI-6x, RFUS-61, RFSTI-11B.
- Temperature measurement with built-in sensor in the range of 0.55 °C, temperature setting in the range of 0 to +55 °C in the weekly program.
- The backlit LCD display displays the current and set temperature, status (ON/OFF), battery status, day of the week, current time, etc.
- Battery power (2x 1.5 V AAA batteries - included in supply) with battery life of around 1 year based on frequency of use.
- Range up to 100 m (in open space), if the signal is insufficient between the controller and unit, use the signal repeater RFRP-20N or protocol component RFIO2 that support this feature.
- Colour combination of temperature unit in design of frames LOGUS⁹⁰ (plastic, glass, wood, metal, stone).

Technical parameters		RFTC-50/G
Supply voltage:	2x 1.5 V AAA batteries	
Battery life:	1 year based on frequency of use according to the number of controlling actuators	
Temperature correction:	2 buttons V / Λ	
Temperature offset:	± 5 °C	
Display:	LCD, characters/see Display description	
Backlighting:	active 10 s after pressing	
Transmission indication/function:	symbols	
Temperature measurement:	1x internal sensor	
Temp. measurement range and accuracy:	0 to +55 °C; 0.3 °C of the range	
Control		
Communication protocol:	RFIO	
Frequency:	866–922 MHz (for more information see p. 81)	
Repeater function:	no	
Signal transmission method:	bidirectionally addressed message	
Range:	in open space up to 100 m	
Minimum control distance:	20 mm	
Other data		
Max. number of control.	4	
RFSA-6x:	4	
Program:	Weekly	
Operating temperature:	0 to + 55 °C	
Operating position:	on the wall	
Mounting:	by gluing/screwing	
Protection:	IP30	
Contamination degree:	2	
Dimensions frame		
- plastic:	85 x 85 x 20 mm	
- metal, glass, wood, granite:	94 x 94 x 20 mm	
Weight:	66 g (without batteries)	
Related standards:	EN 60730, EN 63044, EN 300 220, EN 301 489	

Compatibility				
RF Touch	eLAN-RF	RFSA-6x/RFSAI-6x	RFSTI-11B-SL	RFATV-2
-	-	✓	✓	-

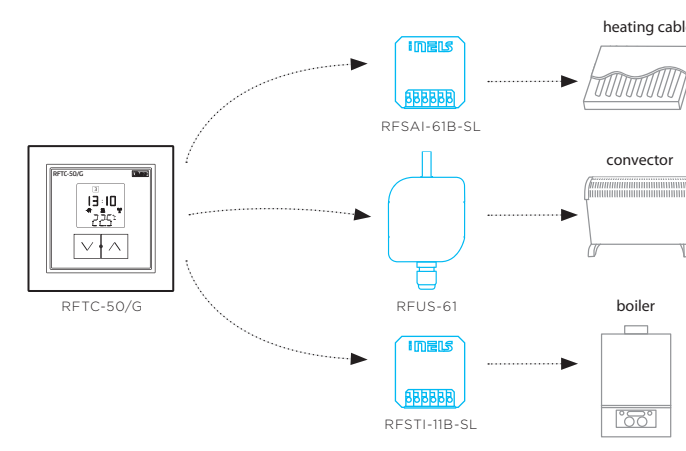
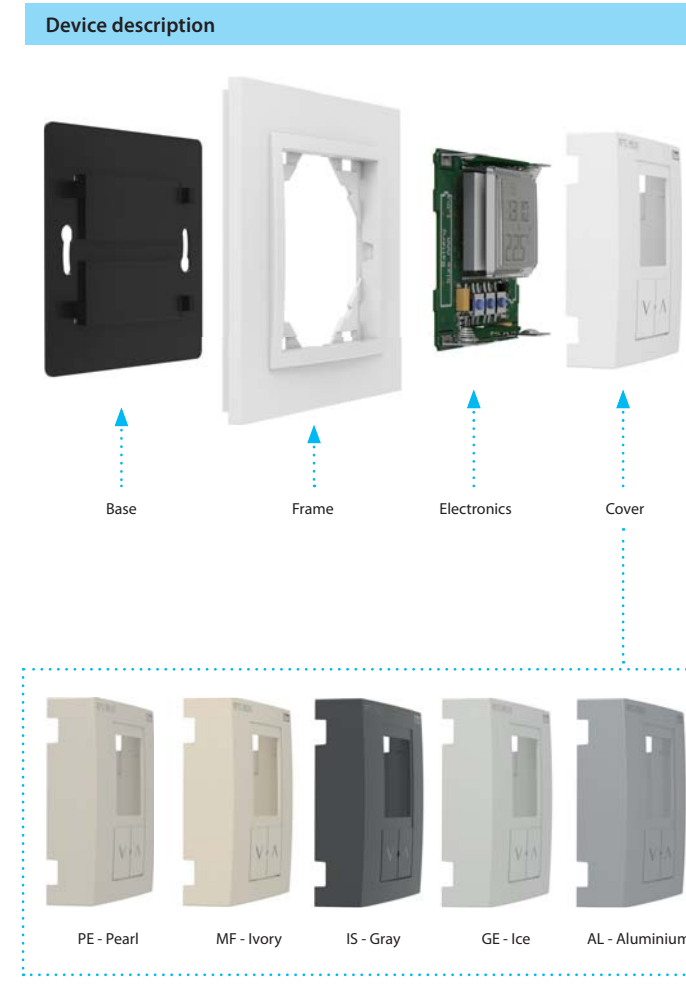
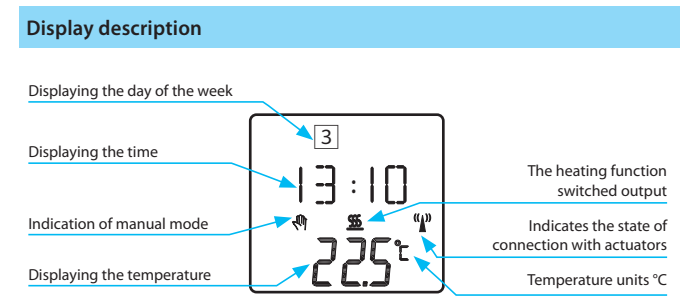



EAN code:
RFSTI-11B-SL: 8595188184045

Technical parameters	RFSTI-11B-SL
Supply voltage:	230 V AC
Supply voltage frequency:	50-60 Hz
Apparent input:	7 VA / $\cos \varphi = 0.1$
Dissipated power:	0.7 W
Supply voltage tolerance:	+10 %; -15 %

Temp. measurement range and accuracy:	-20 to +50 °C 0.5 °C of the range
---------------------------------------	--------------------------------------

Output

Number of contacts:	1x switching
Rated current:	8 A / AC1
Switching power:	2000 VA / AC1
Peak current:	10 A / <3 s
Switching voltage:	250 V AC1
Mechanical service life:	1x10 ⁷
Electrical service life (AC1):	1x10 ⁵

Control

Wireless:	25-channels
Communication protocol:	RFIO2
Frequency:	866–922 MHz (for more information see p. 81)
Repeater function:	yes
Manual control:	button PROG (ON/OFF)
External button/switch:	yes
Range:	in open space up to 200 m

Other data

Operating temperature:	-15 to +50 °C
Operating position:	any
Mounting:	free at lead-in wires
Protection:	IP40
Overvoltage category:	III.
Contamination degree:	2
Connection:	screwless terminals
Connecting conductor:	0.2-1.5 mm ² solid/flexible
Dimensions:	43 x 44 x 22 mm
Weight:	31g
Related standards:	EN 60730, EN 63044, EN 300 220, EN 301 489

- The temperature element measures the temperature with an external sensor and at the same time controls the heating circuit (electric under-floor heating, air conditioning, boiler...).
- They can be combined with Detectors, Controllers or iNELS Wireless system components.
- It measures the temperature in the range -20 to +50 °C and sends it to the system component in a regular 5 min. intervals. It sends a signal when the temperature changes suddenly.
- The heating/cooling, hysteresis and offset functions are set in the system component or application.
- It allows the connection of a switched load up to 8 A (2,000 W).
- Range up to 200 m (outdoors), in case of insufficient signal between the controller and the device, use the RFRP-20N signal repeater or component with the RFIO2 protocol that support this function.
- The BOX version offers installation directly in the installation box, ceiling or cover of the controlled appliance. Easy installation thanks to screwless terminals.
- External sensor TC (-20 to +80 °C) or TZ (-40 to +125 °C) with a length of 3 m, 6 m, 12 m. See „Accessories“ on page 45.

Device description

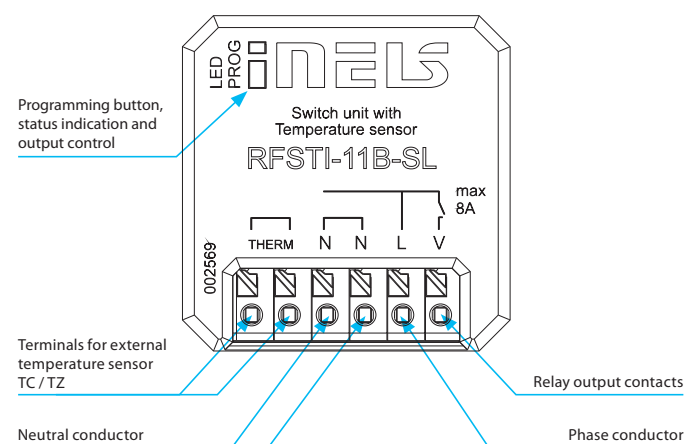

Connection

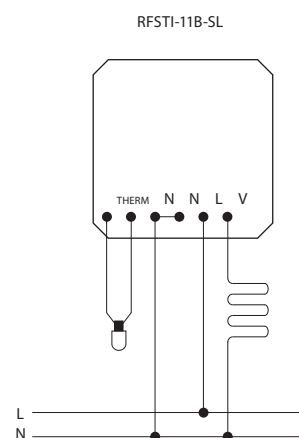

EAN code:
RFTI-20: 8595188134019

Technical parameters	RFTI-20
Supply voltage:	2x 3 V CR 2032 battery
Battery life:	up to 1 year, according to the number of activations
Transmission indication/function:	red LED
Temperature and humidity measurement:	integrated digital sensor
Temperature measurement range and accuracy:	-10 to +50 °C; 0.5 °C of range
Humidity measurement range and accuracy:	0 to 90 %; ±3 % of range
Output	
Communication protocol:	RFIO
Frequency:	866–922 MHz (see p. 81)
Repeater function:	no
Signal transmission:	unidirectional message
Range:	in open space up to 160 m
Other data	
Operating temperature:	-10 to +50 °C
Working position:	any
Mounting:	glue/screws/loose
Protection:	IP30
Contamination degree:	2
Dimensions:	75 x 25 x 14 mm
Weight:	45 g
Related standards:	EN 60730, EN 63044, EN 300 220, EN 301 489

- With an integrated digital sensor, it measures temperature and humidity in the range of -10 to +50 °C and at regular intervals of 20 min. sends it to the system device (eLAN-RF, RF-Touch).
- In the event of a sudden change in temperature and humidity, it sends a signal within 1 min.
- (2x 3 V batteries CR 2032 - included in the package) with a lifetime approx. 1 year (according to ambient temperature cycling).
- Range up to 160m (in open space), in case of insufficient signal between the controller and the device, use RFRP-20N signal repeater or devices with RFIO2 protocol that support this function.

Device description

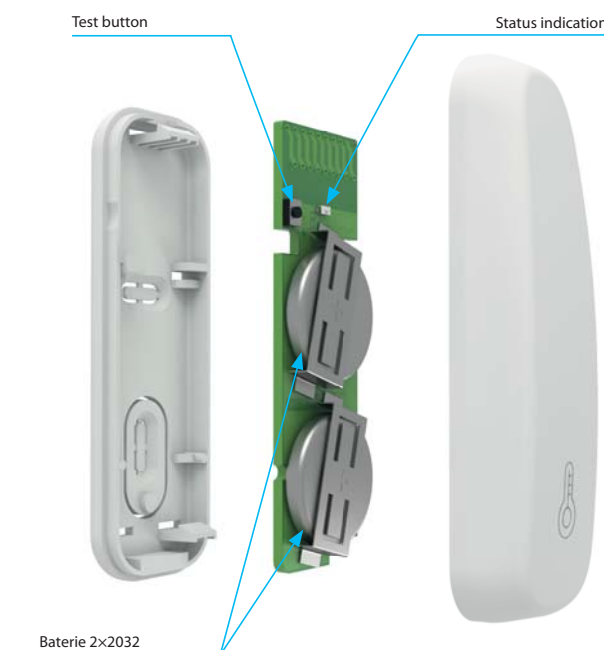



EAN code:
RFATV-2: 8595188182591

Technical parameters		RFATV-2
Supply voltage:	2x 1.5 V battery AA	
Battery life:	1 year based of frequency use	
Control		
Communication protocol:	RFIO	
Frequency:	866–922 MHz (for more information see p. 81)	
Wireless command from controller:	eLAN-RF-103, RF Touch 2	
Range:	in open space up to 200 m	
Other data		
Operating temperature:	0 °C to +50 °C	
Operating position:	any	
Protection:	IP40	
Dimension:	52 x 52 x 70 mm	
Thermo-valve nuts:	M 30 x 1.5	
Related standards:	EN 60730	

- The wireless thermovalve is used to regulate the temperature in the room. It is installed directly on the radiator valve, where it immediately measures the temperature in the room with the help of an internal temperature sensor and regulates the radiator valve with the built-in motor. The valve can also be installed on valves in distribution boards, when a temperature sensor from another element of the iNELS Wireless system will be used to measure the temperature in the room.
- To use the functions of the valve, it is necessary to connect it to the eLAN-RF or RF Touch system units, which will ensure heating and control of the valve from the app (Android, iOS, Samsung Smart TV) and the system unit with manual or automatic temperature modes.
- The valve measures the temperature in the range of 0°C...50°C and receives control instructions from the system units at a regular interval of every 6 minutes.
- The valve supports functions of anti-freeze mode, open window detection, communication failure with system unit and valve stiffening, which are described in detail below.
- The valve supports hysteresis and offset functions that can be set in the application or system unit.
- Battery power 2x AA 1.5 V batteries (included in the package)
- Communication range with system unit up to 200 m (in open space), to increase the range or change the direction of the signal, it is possible to use the RFRP-20NN repeater or other units of the system with support for the repeater function.
- In the base, the head is compatible with M30x1,5 valves, adapters that are not included in the package can be used for other valves.

Device description

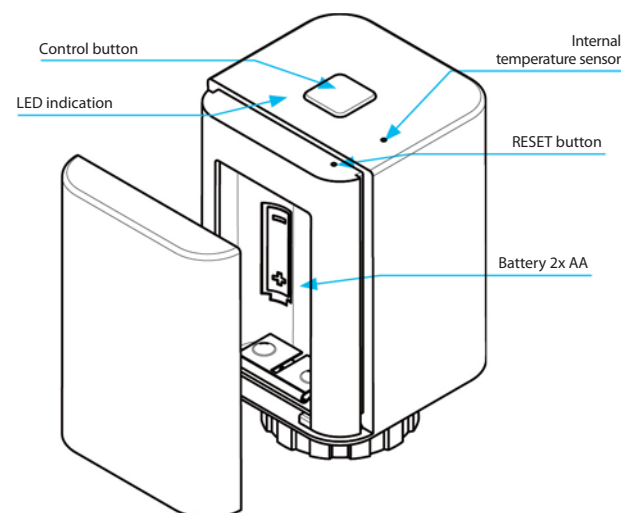

Accessories (not included)

RE-C Reduction Coterm	
RE-DRTD Reduction Danfoss RTD	
RE-D Reduction Danfoss	
RE-G Reduction Giacomini	
RE-M Reduction Myjava	
RE-H Reduction Herz	

TC, TZ | Temperature sensors



EAN code:
TC-0: 8595188110075 TC-6: 8595188110082
TC-3: 8595188110617 TC-12: 8595188110099

Technical parameters	TC	TZ
Range:	-20 to +80 °C (-4 to 176 °F)	-40 to +125 °C (-40 to 257 °F)
Scanning element:	NTC 12K	NTC 12K
Tolerance:	±(0.15 °C + 0.002 t)	±(0.15 °C + 0.002 t)
In air/in water:	(τ0.5) ≤ 18 s	(τ65) 62 s/8 s
In air/in water:	(τ0.9) ≤ 48 s	(τ95) 216 s/23 s
Cable material:	PVC unshielded, 2x 0.25 mm ²	silicon VO35S-F 2D x 0.5 mm ²
Terminal material:	polyamide	stainless steel
Protection degree:	IP67	IP67
Electrical strength:	2500 VAC	2500 VAC
Insulation resistance:	> 200 MΩ at 500 VDC	> 200 MΩ at 500 VDC

Types of temperature sensors:

- length:	TC-0	TZ-0
- weight:	100 mm	110 mm
- length:	TC-3	TZ-3
- weight:	5 g	4.5 g
- length:	3 m	3 m
- weight:	70 g	106 g
- length:	TC-6	TZ-6
- weight:	6 m	6 m
- length:	130 g	216 g
- length:	TC-12	TZ-12
- weight:	12 m	12 m
- weight:	250 g	418 g

τ65 (95): time, which sensor needs to heat up on 65 (95) % of ambient temperature of environment, in which is located.

- Thermister temperature sensors are made of Negative Temperature Coefficient (NTC) embedded in a PVC or metal sleeve with a thermally-conductive sealer.
- Sensor TC**
- lead-in cable to sensor TC is made of wire CYSY 2D x 0.5 mm/0.02".
- Sensor TZ**
- cable VO35S-F 2D x 0.5 mm/0.02" with silicone insulation for use in high temperature applications.
- silicone insulation for use in high temperature applications.
- Temperature sensors can be connected directly to the terminal block
- Cable lengths can not be changed, connected or modified.

Resistive values of sensors in dependance on temperature

Temperature (°C)	Sensor NTC (kΩ)
20	14.7
30	9.8
40	6.6
50	4.6
60	3.2
70	2.3

Tolerance of sensor NTC 12 kΩ is ± 5% by 25 °C/77 °F.

Diagramm of sensor warm up via air

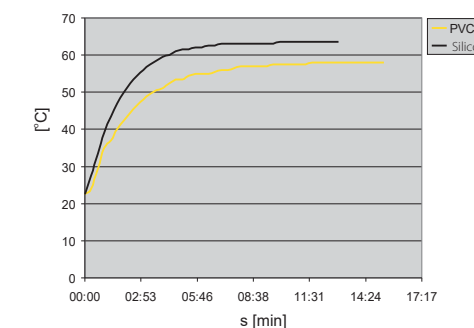

PVC-reaction to water temperature from 22.5 °C to 58 °C.
Silicone - reaction to water temperature from 22.5 °C to 63.5 °C.

Design and dimensions

TC

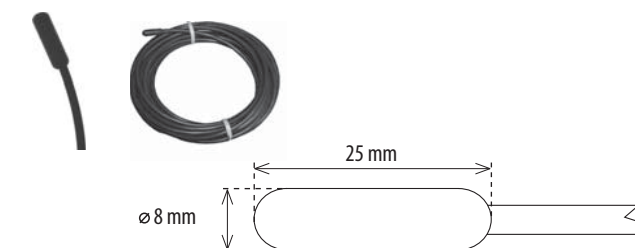

TZ

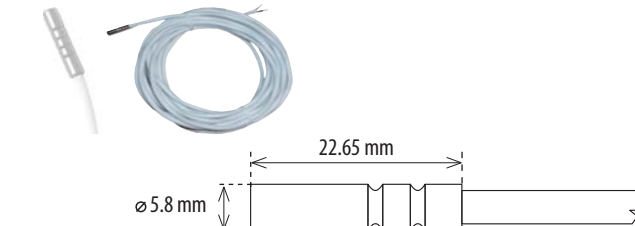

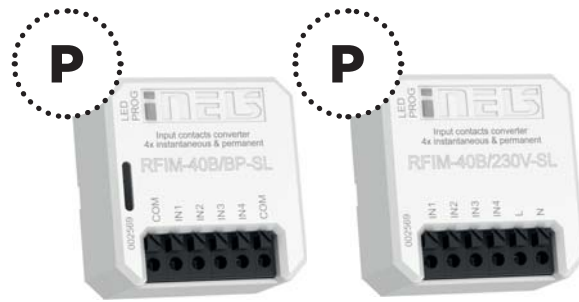

EAN code:
RFIM-40B/BP-SL: 8595188184069

RFIM-40B/230V-SL: 8595188184076

Technical parameters	RFIM-40B/BP-SL	RFIM-40B/230V-SL
Supply voltage:	1x 3 V battery CR 123A	230 V AC
Battery life:	8 years based of frequency use	
Indications/transfer function:	red LED	
Number of inputs:	4	4
Supply voltage tolerance:	+10 %; -15 %	
Control		
Communication protocol:	RFIO2	
Frequency:	866–922 MHz (for more information see p. 81)	
Repeater function:	no	
Signal transmission method:	unidirectionally addressed message	
Range:	in open space up to 200 m	
Other data		
Operating temperature:	-10 to +50 °C	
Operating position:	any	
Line resistance between terminals		
- for closed button:	< 300 Ω	
- for open contact:	> 10 kΩ	
Mounting:	free at lead-in wires	
Protection:	IP40	
Surge category:	III.	
Contamination degree:	2	
Connection:	screwless terminals	
Dimensions:	43 x 44 x 22 mm	
Weight:	37 g	25 g
Contact voltage:	3 V	230 VA
Length of cable to contact:	max. 5 m	max. 100 m
	of parallel lines	
Related standards:	EN 60730, EN 63044, EN 300 220, EN 301 489	

Connection

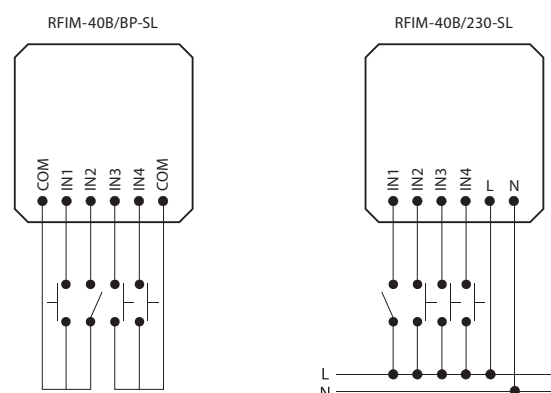

- **RFIM-40B / BP-SL:** the wireless contact converter changes the wired button / switch to wireless.
- 4 inputs allow to control 4 devices independently,
- battery supply (3 V battery CR123A - included in the package) with a lifespan of about 8 years according to the frequency of use,
- the contact can be permanently closed.
- **RFIM-40B / 230-SL:** the contact converter changes the button / switch with local mains supply to wireless.
- 4 inputs allow to control 4 devices independently,
- mains supply, the inputs respond to the supply of mains supply
- It can be used to transmit contact closing information (detector, buttons, technology, logic output).
- When the button is pressed, it sends the set command (ON / OFF, dimming, time off / on, pull / pull).
- Ability to set scenes where you control multiple iNELS Wireless components with a single press.
- Range up to 200 m (outdoors), in case of insufficient signal between the controller and the component, use the RFRP-20N signal repeater or elements with the RFIO2 protocol that support this function.
- The BOX version offers mounting directly in the installation box under the button / switch.
- Attention: The controller is paired with the elements using the pairing button. Ord. codes for controllers with pairing button: RFIM-40B/BP-SL Order No.: 8406, RFIM-40B/230V-SL Order No.: 8407, see Pairing controllers on p. 84.

Device description

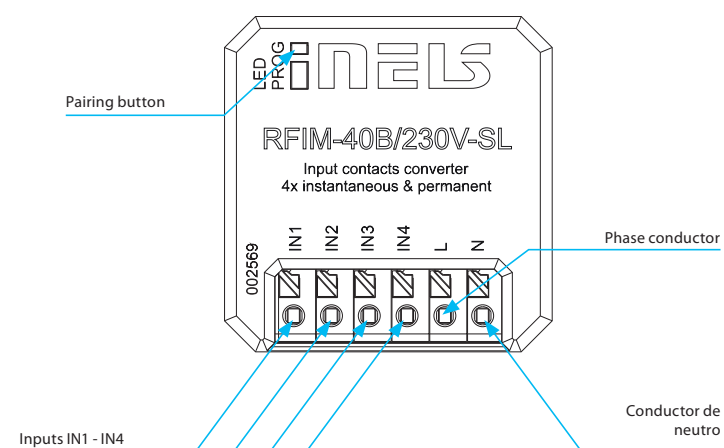
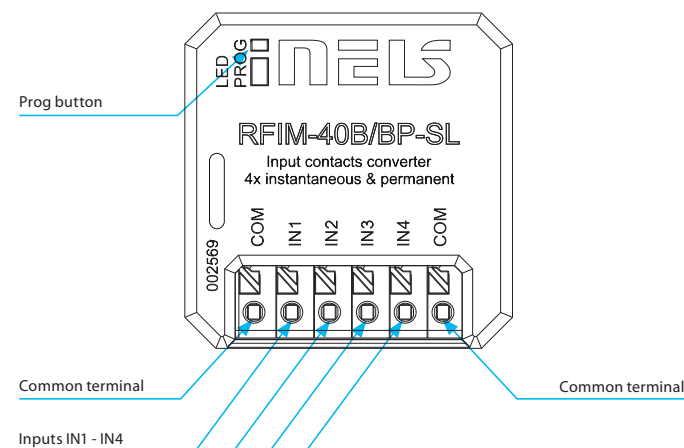

EAN code:
RFSG-1M: 8595188142847

Technical parameters	RFSG-1M
Supply voltage:	110–230 V AC
Supply voltage frequency:	50–60 Hz
Apparent input:	2 VA
Dissipated power:	0.2 W
Supply voltage tolerance:	+10 %/-25 %
Power supply indication:	green LED
Input	
Control voltage:	AC 12–230 V/DC 12–230 V
Control input power:	AC 0.025 VA/DC 0.1 W
Control terminals:	S–S
The length of control impulse:	min. 25 ms (max. unlimited)
Transmission indication/function:	red LED
Control	
Communication protocol:	RFIO
Frequency:	866–922 MHz (for more information see p. 81)
Repeater function:	no
Signal transmission method:	unidirectionally addressed message
Range:	in open space up to 160 m
Minimum control distance:	20 mm
Wireless antenna:	AN-I included (SMA connector)*
Other data	
Operating temperature:	-15 to +50 °C
Operating position:	any
Mounting:	DIN rail support EN 60715
Protection:	IP20 from the front panel
Overvoltage category:	III.
Contamination degree:	2
Connecting conductor	max. 1x 2.5, max. 2x 1.5/ with a hollow max. 1x 2.5
Dimensions:	90 x 17.6 x 64 mm
Weight:	62 g
Related standards:	EN 60730, EN 63044, EN 300 220, EN 301 489

* Max Tightening Torque for antenna connector is 0.56 Nm.

- This wireless contact converter is especially appropriate for wireless transmission of information on switching HDO.
- Thanks to the permanent power supply, it can also be used for partial transmission of information for control of an appliance or device.
- After leading in power to the "S" terminals, it periodically transmits the command switch on in an interval of 2 min. When disconnecting the power supply, immediately switch off.
- The button TEST on the controller is used to assign to a switching unit.
- The package includes an internal antenna AN-I, in case of locating the converter in a metal switchboard, you can use the external antenna AN-E for better signal reception, see accessories on page 66.
- Range up to 160 m (in open space), if the signal is insufficient between the controller and unit, use the signal repeater RFRP-20N.
- 1-MODULE design of the unit with mounting into switchboard.
- The product is suitable for the transmission of control signals within photovoltaic electrical installations.
- Attention: The controller is paired with the elements using the pairing button. Ord. codes for controllers with pairing button: RFSG-1M Order No.: 8240, see Pairing controllers on p. 84.

Device description

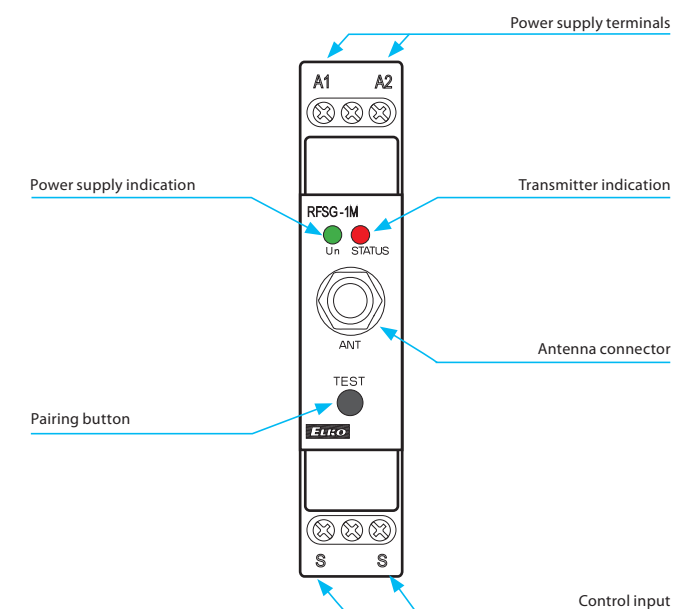

Connection

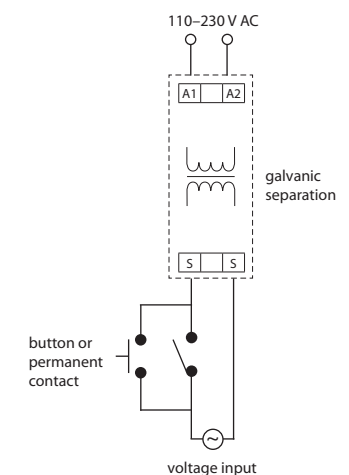



- The wireless pulse converter detects home energy meters (electric, water, gas) by means of sensors, and sends them to the wireless unit eLAN-RF-103.
- Measured values are displayed in the iNELS application iHC-MAIRF/iHC-MIIRF, in daily, weekly or monthly overview in graphs.
- The sensor is designed for use on existing meters and even without the impulse output "SO" (The gauge must support scan).
- RFTM-1 transfers consumption from meters using sensors - LS (LED sensor), WS (Magnetic sensor for meter), MS (Magnetic sensor) or by impulse output („SO“).
- For each consumption meter, it is necessary to have one pulse converter RFTM-1.
- Battery power (2x 1.5 V AAA batteries - included in package) with average battery life of around 2 years (according to the type of scan, frequency of transmissions and pulses).
- Range up to 100 m (in open space), if the signal between the controller and the user is weak, use the signal repeater RFRP-20N or protocol component RFIO2 that support this feature.
- The increased IP65 protection is appropriate for mounting in risers, switchboards and other demanding environments.

Device description

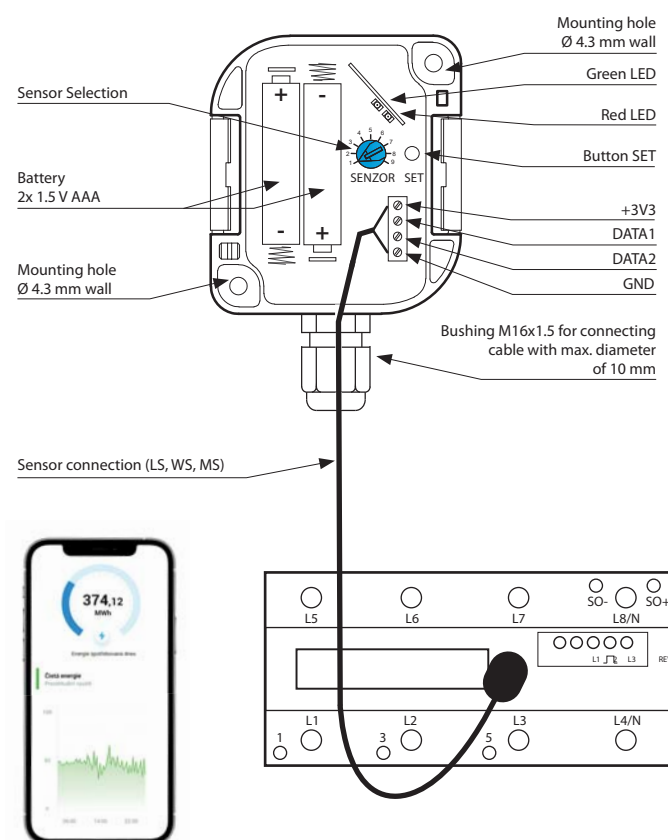

Technical parameters RFTM-1

Power supply:	2x 1.5 AAA batteries
Battery Life:	Appr. 2 years, (depending on the type of sensor, frequency of transmissions and pulses)

Indication

Setting mode:	Green LED flashes - active Red LED - flashes during impulse sensor registration
---------------	--

Communications Test - Wireless STATUS:	Green LED - communication OK Red LED - communication ERR
--	---

Normal operation:	no indication
-------------------	---------------

Control

Manual control:	button SET
-----------------	------------

Sensor Selection:	rotary potentiometer
-------------------	----------------------

Supported sensors (not included in the package):	LS (LED sensor) MS, WS (magnetic sensor) SO (Contact, open collector, reed magnetic contacts)
--	---

Output

Communication protocol:	RFIO
-------------------------	------

Frequency	866–922 MHz (for more information see p. 81)
-----------	--

Range:	in open space up to 100 m
--------	---------------------------

Other data

Working temperature:	-20 to +50 °C *
----------------------	-----------------

Storage temperature:	-30 to +70 °C
----------------------	---------------

Operating position:	any
---------------------	-----

Protection:	IP65
-------------	------

Cross-section of connecting wires:	max. 0.5 - 1 mm ²
------------------------------------	------------------------------

Dimension:	72 x 62 x 34 mm
------------	-----------------

Weight:	104 g
---------	-------

* Pay attention to the operating temperature of batteries.



EAN code:
RFSF-100: 8595188176828

Technical parameters RFSF-100

Power supply	
Battery power:	2x 1.5 V AAA batteries
Battery life by frequency 1x 12 hours:	3 years

Setting

Alarm Detection:	optical and audible alarm
------------------	---------------------------

Battery status view:	low battery is indicated by 5 flashes every 15 minutes or by display in the system element
----------------------	--

Acoustic signal:	greater than 45 dB/1m
------------------	-----------------------

Detection

Sensor:	contacts for flooding
---------	-----------------------

Detection principle:	contact between the sensor sensed liquid
----------------------	--

Response Time:	2 s after connecting the scanning contacts
----------------	--

Measurement accuracy:	99.8 %
-----------------------	--------

Sensitivity:	in the range 0–170 kΩ
--------------	-----------------------

Control

Communication protocol:	RFIO
-------------------------	------

Frequency:	866–922 MHz (for more information see p. 81)
------------	--

Repeater function:	no
--------------------	----

Signal transmission method:	unidirectionally addressed message
-----------------------------	------------------------------------

Range:	in open space up to 160 m
--------	---------------------------

Other parameters

Working temperature:	0 to +50 °C (Pay attention to the operating temperature of batteries)
----------------------	---

Storage temperature:	-20 to +60 °C
----------------------	---------------

Operation position:	capture contacts for flooding downwards
---------------------	---

Mounting:	loose
-----------	-------

Protection degree:	IP62
--------------------	------

Dimension:	Ø 89 x 23 mm
------------	--------------

Weight:	92 g
---------	------

Related standards:	EN 60730, EN 63044, EN 301489, EN 300 220
--------------------	---

Description

- The flood detector is used to detect water leakage - the activation occurs the moment the flooding of the contacts located on the underside of the detector occurs.
- Upon detecting water, the flood detector immediately sends a signal to the switched unit, which further switches on a pump or closes a pipe valve.
- Flood detection is signalled by optical and acoustic signalling.
- Range up to 160 m (in open space); if the signal is insufficient between the controller and unit, use the signal repeater RFRP-20N or protocol component RFIO2 that support this feature.

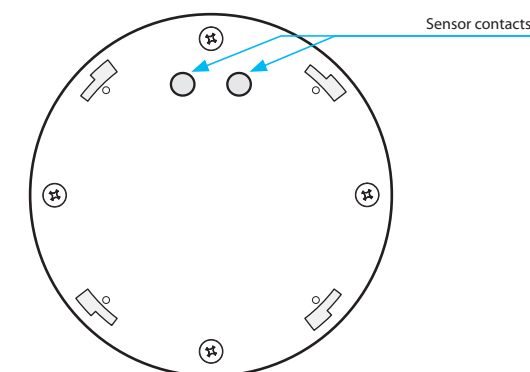

Function

When the scanning contact is connected, the detector sends the message and starts alarm.

Conductivity of liquids

Liquids suitable for detection		Inadmissible liquids
Type of liquid	Resistivity [Ωcm]*	
Drinking water	5–10 kΩ	Demineralised water
Well water	2–5 kΩ	Deionised water
River water	2–15 kΩ	Bourbon
Rain water	15–25 kΩ	Gasoline
Waste water	0.5–2 kΩ	Oil
Seawater	~0.03 kΩ	Liquid gases
Salt water	~2.2 kΩ	Paraffin
Natural/hard water	~5 kΩ	Ethylene glycol
Chlorinated water	~5 kΩ	Paints
Condensed water	~18 kΩ	High alcohol-content liquids
Milk	~1 kΩ	
Milk serum	~1 kΩ	
Fruit juices	~1 kΩ	
Vegetable Juices	~1 kΩ	
Broths	~1 kΩ	
Wine	~2.2 kΩ	
Beer	~2.2 kΩ	
Coffee	~2.2 kΩ	
Soap toam	~18 kΩ	

* Resistivity characterizes the resistive properties of materials which conduct electric current.



EAN code:
RFSOU-1: 8595188147071

Technical parameters		RFSOU-1
Power supply:	2 x 1.5 AAA batteries	
Battery Life:	Appr. 2 years, according to the number of controlled units	
Setting the range of light levels		
Function ☾ (twilight switch)		
- Range 1:	1 to 10 lx	
- Range 2:	10 to 100 lx	
- Range 3:	100 to 1.000 lx	
Function ☀ (light switch)		
- Range 1:	100 to 1 000 lx	
- Range 2:	1 000 to 10 000 lx	
- Range 3:	10 000 to 100 000 lx	
Function setting:	rotary switch	
The level of lighting gently:	0.1 to 1 x range	
Fine adjustment of lighting levels:	potentiometer	
The time delay t:	0/1 min./2 min.	
Setting the delay time t:	rotary switch	
Control		
Communication protocol:	RFIO	
Frequency:	866–922 MHz (for more information see p. 81)	
Repeater function:	no	
Range:	in open space up to 160 m	
Other data		
Working temperature:	-20 to +50 °C	
Storage temperature:	-30 to +70 °C	
Operating position:	sensor side down	
Protection:	IP65	
Degree of pollution:	2	
Dimension:	72 x 62 x 34 mm	
Weight:	104 g	
Standards:	EN 60730, EN 63044, EN 300 220, EN 301 489	

- The twilight switch measures the light intensity and based on a set value, it sends the command to switch on the lights or pull the blinds up or down.
- It can be combined with multifunctional switching units and blind switches.
- Integrated sensor for measuring illumination, settable in 3 ranges 1-100,000 lx.
- Selection of function:
 - a) twilight switch – automatically switches on upon a decrease in ambient light intensity, switches off upon an increase (appropriate for garden lights, advertisements, public lighting, etc.).
 - b) light switch – automatically switches on upon an increase in ambient light intensity, switches off upon a decrease (appropriate for offices, restaurants, rooms, etc.).
- Settable delay up to 2 minutes to eliminate unwanted switching caused by surrounding influences.
- The twilight switch may control up to 32 units in the installation.
- The programming button on the regulator is used for:
 - a) setting a function with a switching or blind unit
 - b) ascertaining battery status
 - c) ascertaining signal quality between the unit and dimmer.
- Battery power (2x 1.5 V AAA batteries - included in supply) with battery life of around 2 years based on the number of controlled units.
- Range up to 160 m (in open space), if the signal is insufficient between the controller and unit, use the signal repeater RFRP-20N or protocol component RFIO2 that support this feature.

Device description

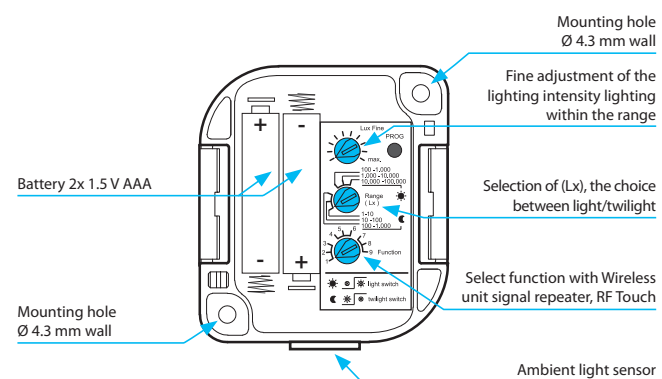

EAN code:
RFWD-100: 8595188150279

Technical parameters	RFWD-100
Power supply:	1x 3 V CR 2032 battery
Drained battery indicator:	yes
Control	
Communication protocol:	RFIO
Frequency:	866–922 MHz (for more information see p. 81)
Repeater function:	no
Other data	
Working temperature:	-10 to +50 °C
Protection:	IP20
Colour:	white
Dimension:	25 x 75 x 16 mm
Magnet dimension:	15 x 75 x 14 mm
Standards:	EN 60730, EN 63044, EN 301489, EN 300 220

- The Window/Door detector is used to detect opening where activation occurs when the magnet and the sensor become separated.
- Use:
 - in combination with the switching unit for automatic light control (cellar, garage, etc.).
 - by means of the Smart RF gate, detection can be displayed on your smart phone in the form of a notification; alarms are stored in the history, which is visualized in the iNELS application.
- Anti-tamper function: an alarm is triggered if there is an unauthorized interference to detector.
- Power supply: 1x 3 V CR 2032 battery, the battery life is around 1 year, thanks to the ability to turn off the LED indicator it is possible to extend up to 3 years.
- "Low Battery" Alerts on Your iNELS App.
- The detectors are compatible with switching components marked with the RFIO2 communication protocol and the eLAN-RF system components.



- The motion detector PIR is used to detect persons moving inside the building interior.
- Use:
 - in combination with a switching unit for automatic control of lighting or triggering an alarm.
 - by means of the Smart RF gate, detection can be displayed on your smart phone in the form of a notification; alarms are stored in the history, which is visualized in the iNELS application.
- Sensitivity settings of the PIR detector for eliminating unwanted triggering.
- Integrated lighting sensor, thanks to which you can set the detector's reaction time.
- Option of activation/deactivation of the LED indicator on the detector cover.
- Anti-tamper function: an alarm is triggered if there is an unauthorized interference to detector.
- Power supply: 2x 1.5 V AA batteries, the battery life is around 1 year.
- "Low Battery" Alerts by double LED flashing or on iHC App.
- The detectors are compatible with switching components marked with the RFIO2 communication protocol and the eLAN-Wireless system components.

Detection field

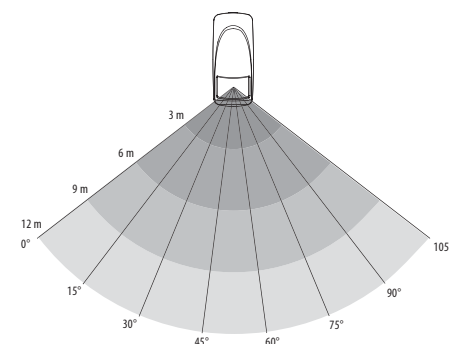

EAN code:

RFMD-100: 8595188150293

Technical parameters		RFMD-100
Power supply:	2x 1.5 V AA batteries	
Battery life:	up to 1 year, according to the number of activations	
Drained battery indicator:	yes	
Control		
Communication protocol:	RFIO	
Frequency:	866–922 MHz (for more information see p. 81)	
Repeater function:	no	
Detection angle:	105°	
Detection distance:	max. 12 m	
Recommended working height:	max. 2.4 m	
Other data		
Working temperature:	-10 to +50 °C	
Protection:	IP20	
Colour:	white	
Dimension:	46 x 105 x 43 mm	
Weight:	57 g	
EMC resistance:	level 2	
Related standards:	EN 60730, EN 63044, EN 301489, EN 300 220	



- The motion detector PIR is used to detect presence persons moving inside the building interior.
- Use:
 - in combination with a switching unit for automatic control of lighting or triggering an alarm.
 - by means of the Smart RF gate, detection can be displayed on your smart phone in the form of a notification; alarms are stored in the history, which is visualized in the iNELS application.
- In combination with hotel elements (HRESK) it can serve as a room occupancy sensor
- Sensitivity settings of the PIR detector for eliminating unwanted triggering.
- Option of activation/deactivation of the LED indicator on the detector cover.
- Power supply: 2x 1.5 V AA batteries, the battery life is around 1 year.
- "Low Battery" Alerts by double LED flashing or on iHC App.
- The detectors are compatible with switching components marked with the RFIO2 communication protocol and the eLAN-Wireless system components.

EAN code:

RFMD-200: 8595188189194

Technical parameters		RFMD-200
Power supply:	2x 1.5 V AA batteries	
Battery life:	up to 1 year, according to the number of activations	
Drained battery indicator:	yes	
Control		
Communication protocol:	RFIO	
Frequency:	866–922 MHz (for more information see p. 81)	
Repeater function:	no	
Detection angle:	110°	
Detection distance:	max. 9.5 m	
Recommended working height:	max. 2.5 m	
Other data		
Working temperature:	-10 to +50 °C	
Protection:	IP20	
Colour:	white	
Dimension:	ø 95mm, height incl. lens 30mm	
Weight:	113 g	
Related standards:	EN 60730, EN 63044, EN 301489, EN 300 220	

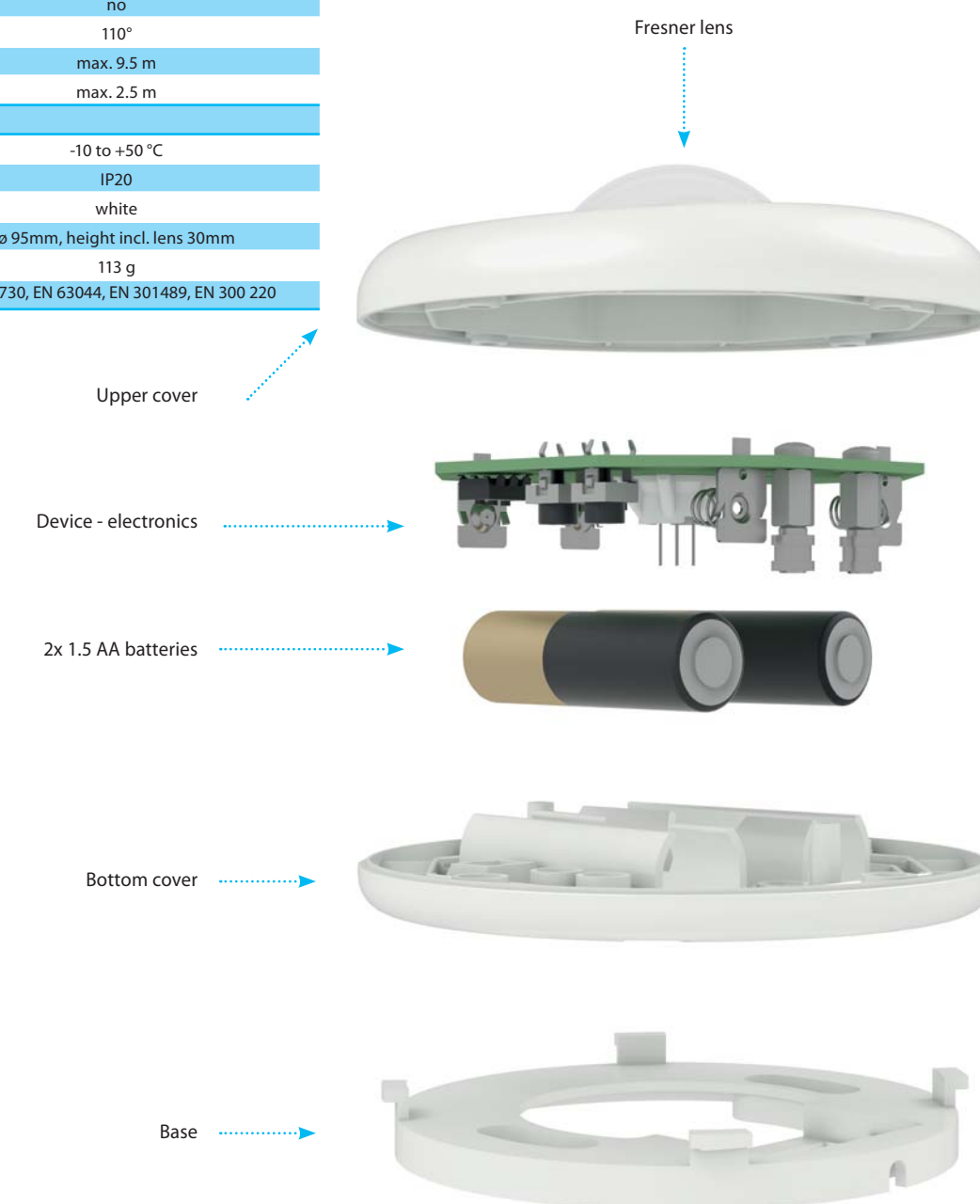



EAN code:
8595188183994

Technical parameters		RFSLT-S3
Power supply:	Battery (lithium cell, 3V6-AA-LS)	
Input	Pressure sensor with digital connection	
Probe cable length:	standard 3m	
Measuring range:	standard 0-3m H ₂ O (other by agreement)	
Measurement frequency:	1x / min	
Output		
Relay:	up to 6 relays	
Alarm:	wireless relay	
Output update frequency:	1x min (only when changing the level)	
Accuracy:	± 0,5%	
Time response:	≤ 100ms	
long-term stability:	≤ ± 0,2 % span / year under reference conditions	
Mechanical stability:		
vibrations	10g, 25 Hz...2 kHz	
shocks	100g / 1ms	
Electrical resistance		
Short circuit protection:	permanent	
Reverse polarity protection:	approx. 1 year (according to ambient temperature cycling)	
Electromagnetic compatibility:	radiation and immunity to interference according to EN 61326	
Control		
<i>INELS standard</i>		
Communication protocol:	RFIO	
Frequency:	866-922 MHz (for more information see p. 81)	
Repeater function:	no	
Manual control:	application	
Range:	in open space up to 200 m	
Minimum control distance:	20 m	
<i>Bluetooth</i>		
Communication protocol:	Bluetooth Low Energy	
Frequency:	2,4GHz	
Repeater function:	no	
Manual control:	application	
Range:	in open space up to 50 m	
Other data		
Operating temperature:	-20 to +40 °C	
Working position:	any	
Mounting:	screws	
Protection:	IP65, probe IP68	
Recommended power cable:	The sensor including the cable is included in the package	
Dimension:	136 x 62 x 34 mm	
Weight:	150 g	
Standards:	EN 60730, EN 63044, EN 300 220, EN 301 489, EN 300 328	

- It measures the level of liquids based on the principle of hydrostatic pressure measurement.
- It consists of a communication unit in a plastic case with IP65 protection placed above the surface and a stainless steel pressure probe connected by a cable lowered to the bottom of the tank.
- The standard length of the probe cable is 3m or 9m.
- The unit communicates wirelessly via the RFIO2 protocol with the devices of the iNELS RF Control system and is powered by a 3V6 lithium battery. The range of the switching actuators from the unit is determined by the building/location, in open space it is normally 200 meters.
- The unit can also communicate with the eLAN-RF-103 gateway, which conveys level information to the iNELS application.
- In the application, it is possible to manage switching actuators, edit notifications, continuously monitor the level, pressure, temperature and battery discharge status in the unit.
- The unit itself is set up via the iSonda application from an Android/iOS smartphone via the Bluetooth interface (LowEnergy, 4.1 and higher).

Function

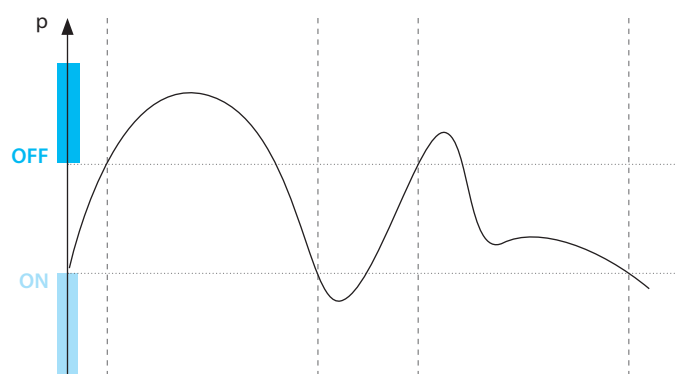
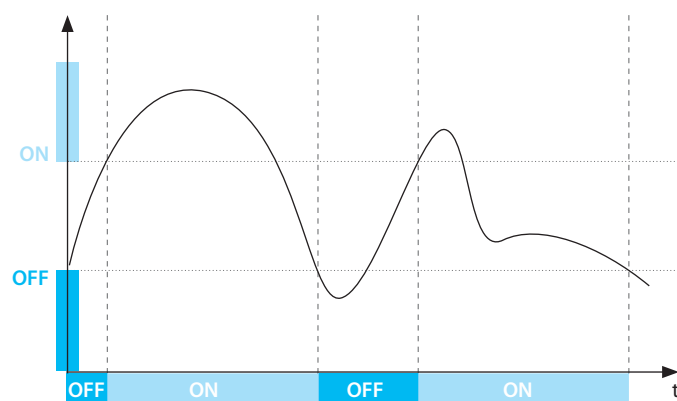

Materials (in contact with the medium)

Housing:	stainless steel 1.4301 (304)
Seal:	FKM
Membrane:	stainless steel 1.4435 (316 L)
Cable jacket:	PUR

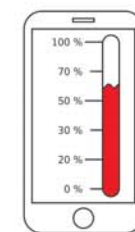
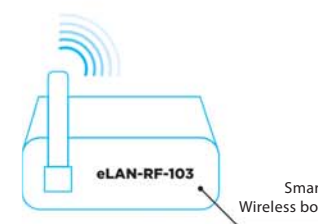
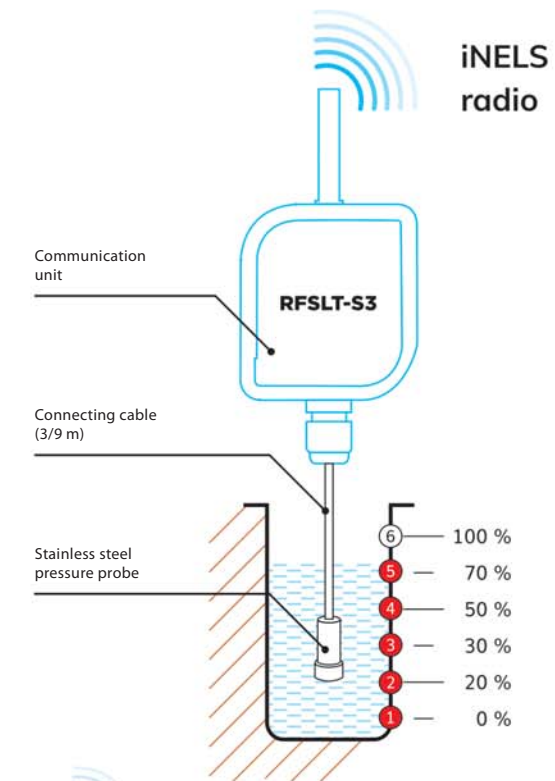

Signaling via the application on the phone

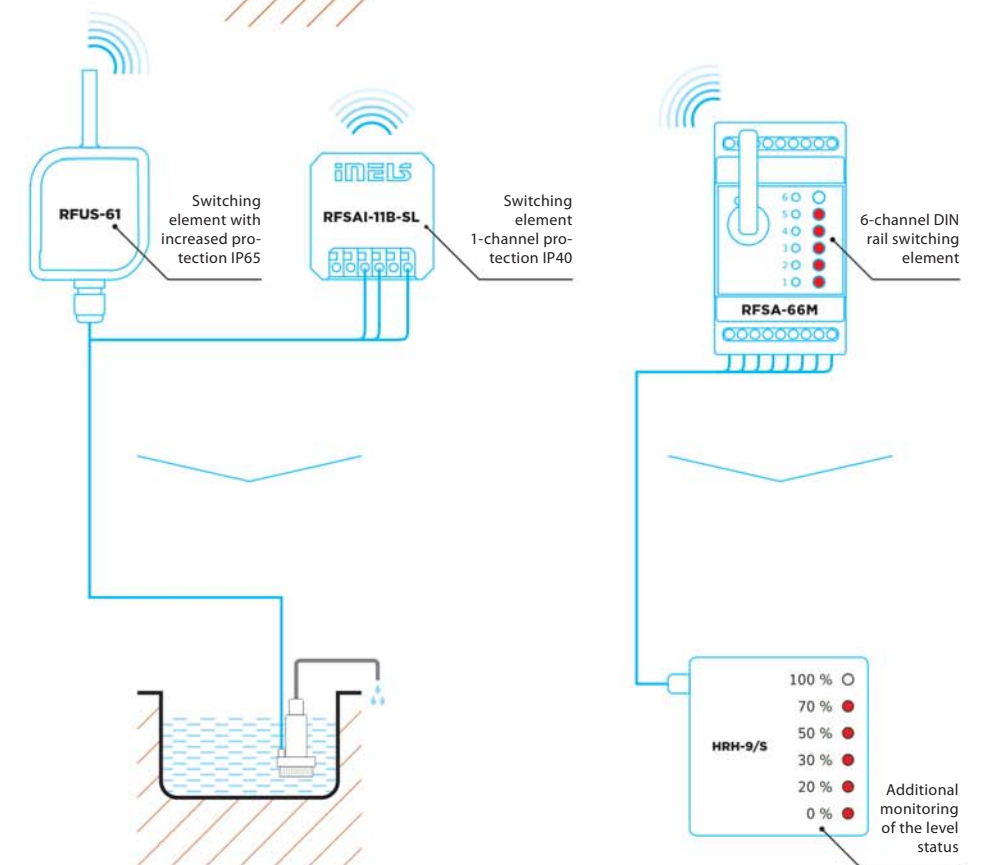

Control of 1 pump: **RFSAI-11B-SL, RFUS-61**
Control of 2 pumps: **RFS-62B-SL**

Control/signaling, 6x output
(eg: MAX / MIN / CRITICAL MAX / CRITICAL MIN)



EAN code:
RF TOUCH-2/BE: 8595188182669
RF TOUCH-2/BR: 8595188189743

Technical parameters	RF Touch-2/BE	RF Touch-2/BR
Display		
Type:	color TFT LCD 4"	
Distinction:	480 x 480 pixels	
Aspect Ratio:	72 x 72 mm	
Visible area:	active (white LED)	
Backlight:	capacitive	
Power supply		
USB-C:	5V	5V
Passive PoE:	24V	—
Terminal plate:	(10-30V DC)	
Power consumption:	max. 3 W	
Communication		
Radio		
Communication protocol:	RFIO2	
Frequency:	866–922 MHz (for more information see p.81)	
Range:	open space up to 200 m	
Min. distance RF Touch component:	1 m	
WiFi		
Protocols:	802.11 b/g/n (802.11n to 150 Mbps) A-MPDU and A-MSDU	
Frequency:	2.4 GHz	
LAN		
Ethernet:	100 Mbit/s	
Sensors and notifications		
Temperature sensor	0-50 °C; 0.2 °C out of range	
Humidity sensor	0-100%; 2% of range (RH)	
Proximity sensor	15cm	
Notification LED	RGB	
Operating conditions		
Operating temperature:	0 to +50 °C	
Storage temperature:	- 20 to +70 °C	
Cover:	IP20	
Surge category:	III.	
Degree of pollution:	2	
Working position:	any	
Installation:	into the installation box	
Dimensions:	86 x 86 x 10 (37)	
Weight (plastic):	120 g	
Related standards:	EN 60730, EN 63044, EN 300 220, EN 301 489, EN 300 328	

- RF Touch-2 touch control unit is a system element used for automatic and manual control of switching, dimming, or blind elements and heating control elements within the iNELS Wireless system.
- The control unit is available in two versions:
 - RF Touch-2/BE – professional version powered via PoE, USB-C, or 10-30V DC screwless terminals and communicating via Wi-Fi and LAN for connection in new home installations, hotels, hospitals, and office buildings
 - RF Touch-2/BR – simpler version with powered via USB-C or 10-30V DC screwless terminals and communicating via Wi-Fi for easy connection in renovated rooms without having to connect to the local network
- Both versions communicate wirelessly with iNELS Wireless units using radio frequency and allow up to 40 wireless element addresses and 30 detectors to be connected in this way.
- RF Touch-2 touch unit also serves as a communication gateway, so besides direct control via the 4" capacitive display, it allows communication with the system via the iNELS app and provides connection to the iNELS Cloud.
- A great advantage of the unit is that it supports the MQTT protocol, thus allowing controlling it via HomeKit, Home Assistant, and other Smart Home and professional BMS integrations.
- RF Touch-2 unit offers a range of automatic functions that can be used even when not connected to a local network, such as controlling heating modes, timers, light scenes, and leaving buttons.
- RF Touch-2 features integrated temperature and humidity sensors for controlling heating modes and a proximity sensor for non-contact lighting of the display.
- Innovative design allows for easy installation in a mounting box

Device description

LAN cable for Ethernet communication and PoE power supply (only available with RF Touch-2/BE version)

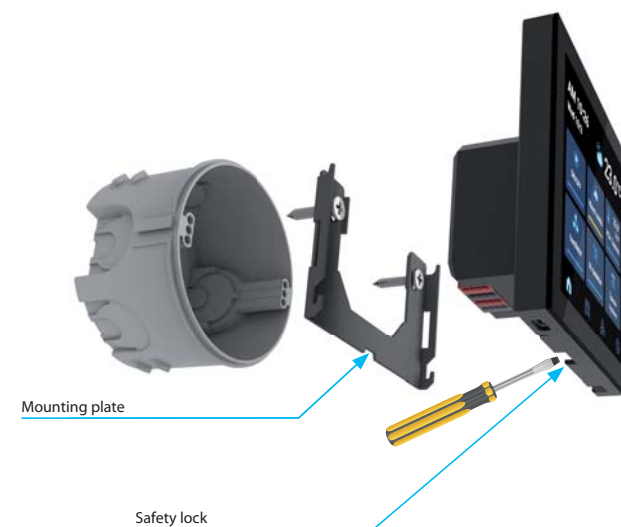
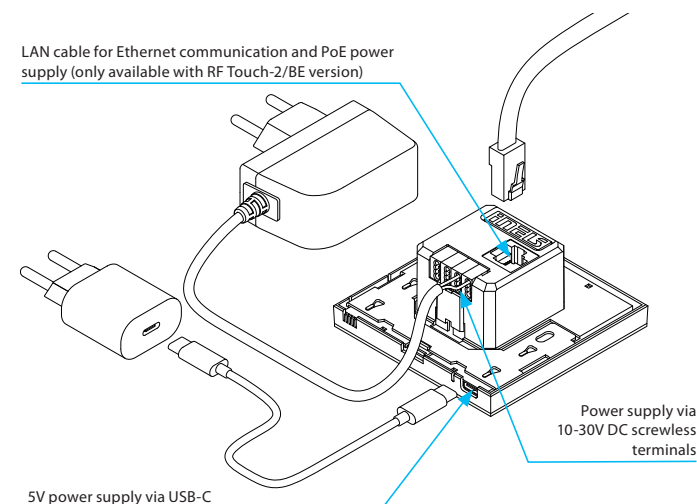

Communication diagram

Communication with RF Touch-2 can be direct (fixed IP) or indirect (via iNELS cloud).



Screen preview





EAN code:
eLAN-RF-103: 8595188180443

Technical parameters		eLAN-RF-103
Interface Wireless Control		
Communication protocol:	RFIO2	
Broadcasting frequency:	866–922 MHz (for more information see p. 81)	
Signal transfer method:	two-way addressed message	
Output for antenna:	SMA connector*	
Antenna Wireless:	AN-I 1 dB	
Indications Wireless communications:	1x green RF LED	
Range:	in open space up to 100 m	
Interface Ethernet		
ETH operating status indicator:	green LED	
ETH communication indicator:	yellow LED	
Communications interface:	100 Mbps (RJ45)	
Preset IP address:	DHCP	
Power supply		
Supply voltage/current:	5 V DC/0.5 A	
Power source:	110–230 V AC/5 V DC–2 A (connector USB-C)	
Button RESET		
- short press:	restart the device	
- press > 5 s:	reset network settings	
- press > 10 s:	reset to factory settings	
Indication LED STATUS		
- green:	normal mode	
- red:	error condition	
- orange:	initialization/start	
Other data		
Operating temperature:	-20 to +50 °C	
Storage temperature:	-25 to +70 °C	
Protection:	IP20	
Contamination degree:	2	
Working position:	any	
Dimensions:	90 x 52 x 65 mm	
Weight:	136 g	
* Max Tightening Torque for antenna connector is 0.56 Nm.		

- The Smart Wireless Box is a gateway between iNELS Wireless elements and applications for smartphones, tablets, watches, televisions, voice assistants (Google Home & Alexa) and other third-party devices.
- It is produced in two versions:
 - eLAN-RF-103: LAN communication
- It communicates from up to 70 iNELS Wireless elements, processes set programs for automatic control.
- Thanks to two-way communication, it displays the current status of individual elements.
- Powered by 5 V DC/2 A adapter, USB-C connector (included).
- Configuration is done via the iHC application.
- The package includes an internal antenna AN-I, in case the Smart Wireless gate is located in a metal switchboard, you can use the external antenna AN-E for better signal reception, see accessories on p. 76. For the eLAN-RF-Wi-103 version.
- Supports the MQTT protocol, which enables two-way communication between the eLAN-RF-103 and therefore also with the entire iNELS Wireless system with platforms such as Home Assistant, HomeKit and other Smart Home and building management systems.

Device description

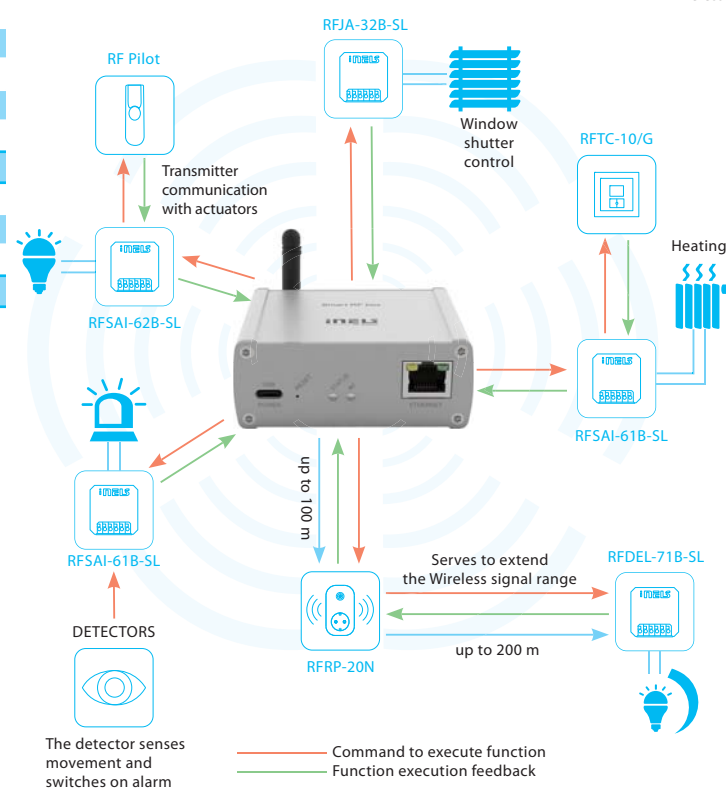
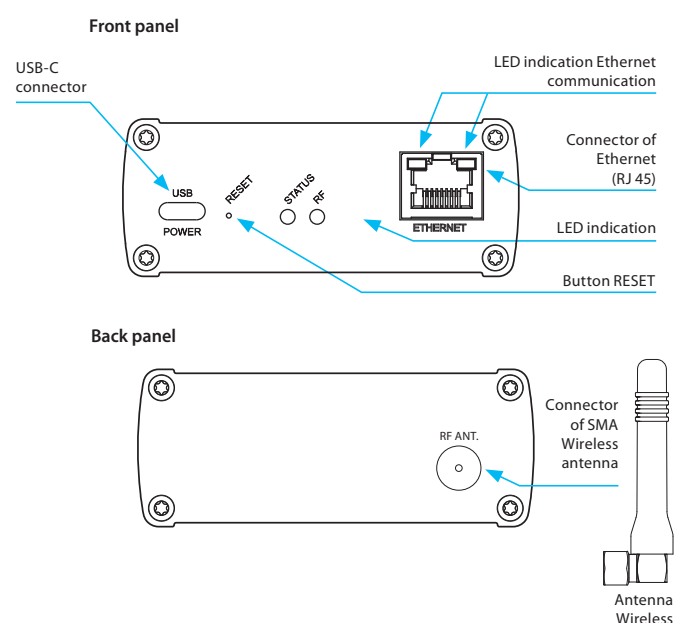

EAN code:
RFRP-20NN/Schuko: 8595188145473 RFRP-20NN/British: 8595188145480
RFRP-20NN/French: 8595188145107

Technical parameters		RFRP-20N/230V
Supply voltage:	230V	
Supply voltage frequency:	50-60 Hz	
Apparent input:	7 VA / $\cos \varphi = 0.1$	
Dissipated power:	0.7 W	
Supply voltage tolerance:	+10%/-15%	
Control		
Communication protocol:	RFIO2	
Frequency:	866–922 MHz (for more information see p. 81)	
Range:	in open space up to 200 m	
Minimum control distance:	20 mm	
Programming:	button - green LED/red LED	
Other data		
Operating temperature:	-20 to +55 °C	
Storage temperature:	-30 to +70 °C	
Mounting:	plug into a socket	
Protection:	IP20 Device	
Dimensions:	63 x 110 x 74 mm	
Weight:	115 g	
Related standards:	EN 60730, EN 63044, EN 300 220, EN 301 489	

Produced in 3 designs of sockets/plugs:



- The signal repeater is used to increase the range between the controller and the device by up to 200 meters.
- It is designed for signal transmission up to 20 components.
- Indications:
 - green LED - supply voltage,
 - red LED - active status (receiving and transmitting Wireless signal).
- Programming is done with the key.
- Thanks to the socket design, installation is simple by plugging it directly into the existing socket, the function of the through socket will be retained.

Signal transmission and extension for up to 20 components.

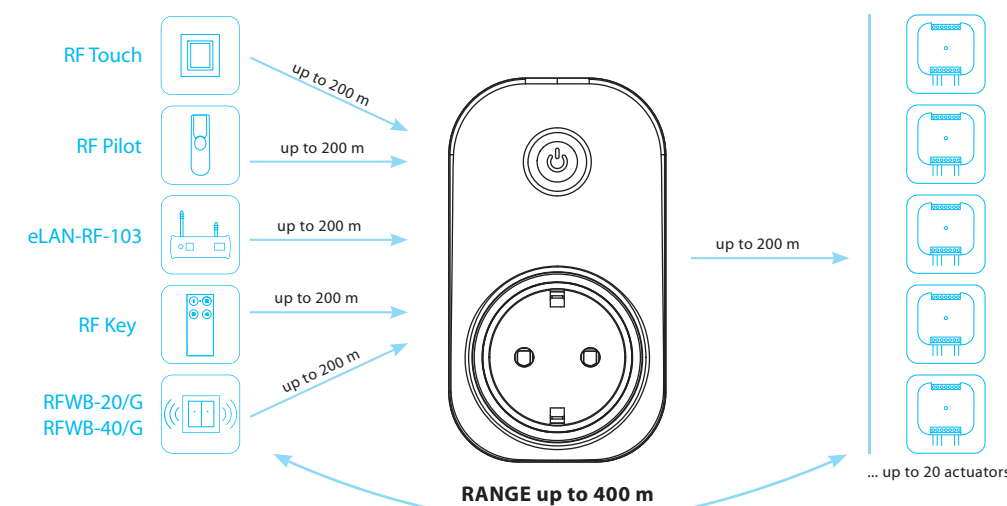

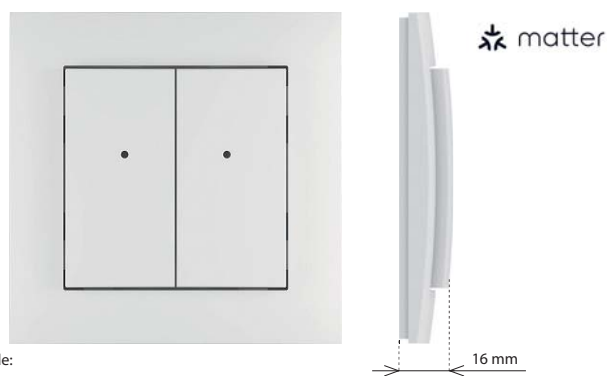

EAN code:
RFWB-40G/MT: 8595188189545

- The pushbutton type wall-mounted controllers are used to control switches and dimmers (of lights, barriers, gates, window shutters, etc.).
- It communicates on the Thread protocol that guarantees compatibility with other products with the Matter support.
- Its flat design with a flat base predestines it for quick installation on any surface (by sticking or screwing it onto a junction box).
- After a short pressing the pushbutton, it transmits the preset command (short pressing, long pressing).
- Transmission of the command is indicated by a red LED.
- Design of the LOGUS90 switch frames (plastics, glass, wood, metal, stone).
- Battery power supply (3V battery CR 2032 is included) with lifetime of approx. 2 years, depending on the frequency of use.
- The applicable reach is up to 200m (in free area).
- The element with the actuator can be paired through a border router supporting Matter and through an application supporting Matter. The border router is understood as equipment such as HomePod Mini, Google Nest Hub or Samsung SmartThings Station.

Device description

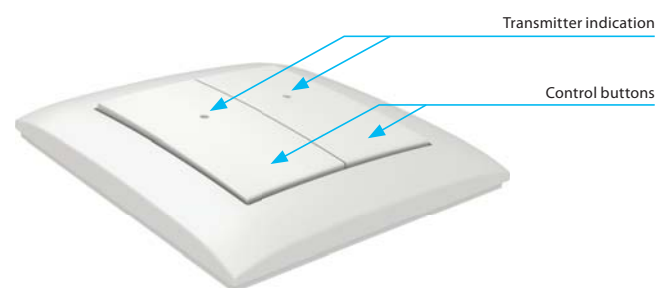

Technical parameters		RFWB-40G/MT
Supply voltage:		3 V CR 2032 battery
Battery life:		around 2 years based on frequency of use
Transmission indication:		red LED
Number of buttons:		4
Application protocol:		Matter
Communication protocol:		THREAD
Frequency:		2,4 GHz
Signal transmission method:		MESH
Range:		in open space up to 200 m
Other data		
Operating temperature:		-10 to +50 °C
Operating position:		any
Mounting:		glue/screws
Protection:		IP20
Contamination degree:		2
Dimensions frame		
- plastic:		85 x 85 x 16 mm
- metal, glass, wood, granite:		94 x 94 x 16 mm
Weight (plastic):		39 g
Related standards:		EN 60730, EN 63044, EN 301489, EN 300328



LOGUS⁹⁰

Choose your own style

Flat wireless switches that can be mounted on glass, tile, furniture ...
Such a quick change of location when you're moving.

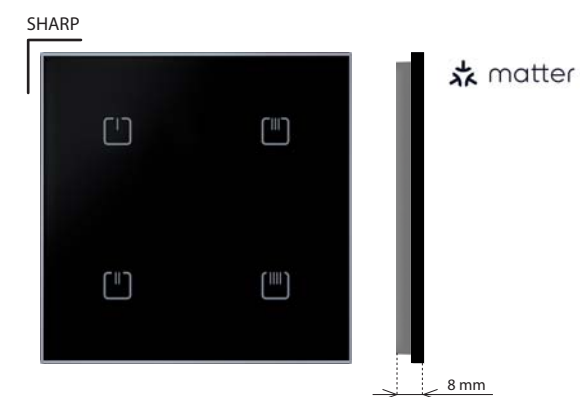

EAN code:
RFGB-40W/MT: 8595188189774
RFGB-40B/MT: 8595188189767

Technical parameters		RFGB-40B/MT, RFGB-40W/MT
Supply voltage:		2x 3 V CR 2032 batteries
Battery life:		around 2 years based on frequency of use
Transmission indication:		red LED
Number of capacitive buttons:		4
Application protocol:		Matter
Communication protocol:		THREAD
Frequency:		2.4 GHz
Signal transmission method:		MESH
Range:		in open space up to 200 m
Other data		
Operating temperature:		-10 to +50 °C
Operating position:		any
Mounting:		glue/screws
Protection:		IP20
Contamination degree:		2
Dimensions:		94 x 94 x 8 mm
Weight:		107 g
Related standards:		EN 60730, EN 63044, EN 301489, EN 300328

- Glass touch controller in an elegant black or white glass variant with a width of only 8 mm.
- Communicating on the Thread protocol, which guarantees compatibility with other Matter-enabled products.
- 4 capacitive buttons allow you to control 4 independent devices.
- After pressing the button, it sends the set command (short press, long press). Sending a command is indicated by a red LED.
- The flat mounting base allows installation with screws, double-sided tape or placement on the table.
- Battery power (2x 3 V batteries CR 2032 - part of the package) with a lifespan of approx. 2 years depending on the frequency of use.
- Range up to 200 m (in open space).
- The element with the actuator can be paired through a border router supporting Matter and through an application supporting Matter. The border router is understood as equipment such as HomePod Mini, Google Nest Hub or Samsung SmartThings Station.

Device description

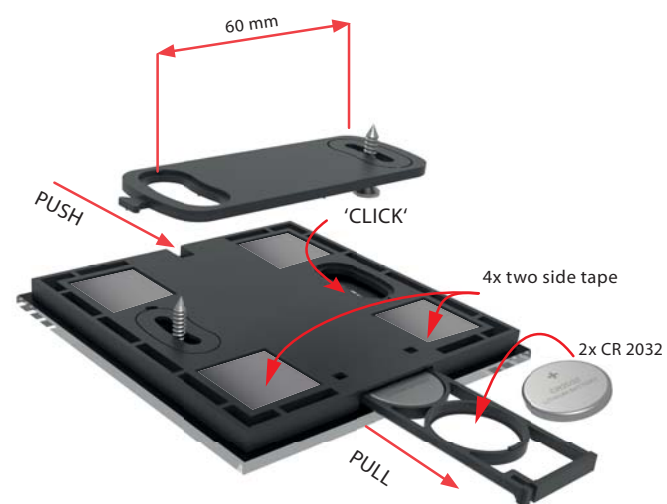
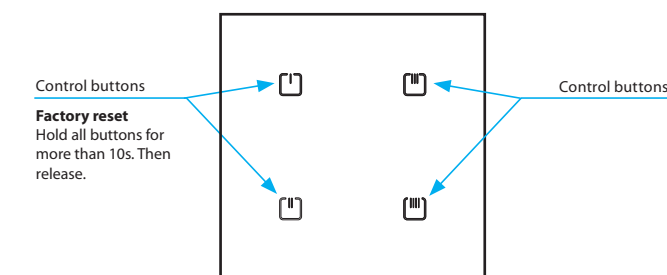

Variants





- The switching element with two output relays can be used to control some appliances and lights.
- The Thread protocol guarantees compatibility with other products with the Matter support.
- The wireless controllers (RFGB-40/MT) and also the existing wired switches/pushbuttons can be used for control.
- The BOX-SL design offers installation directly in the junction box, soffit or cover of the controlled appliance. Easy connection of wires thanks to the screw-free terminals.
- The applicable reach is up to 200m (in free area).
- The maximum switched power is 2000W (8A), the relay contact material AgSnO₂ + Zero Cross predestines it for switching of lighting loads.
- The reset pushbutton on the element can also be used as manual control of the input.
- The element with the controller can be paired through a border router supporting Matter and through an application supporting Matter. The border router is understood as equipment such as HomePod Mini, Google Nest Hub or Samsung SmartThings Station.

EAN code:
RFSAI-62B-SL/MT: 8595188189750

Technical parameters	RFSAI-62B-SL/MT
Supply voltage:	230 V AC
Supply voltage frequency:	50-60 Hz
Apparent input:	7 VA / $\cos \varphi = 0.1$
Dissipated power:	0.7 W
Supply voltage tolerance:	+10%/-15%
Output	
Number of contacts:	2x switching
Rated current:	8 A / AC1 (in total)
Switching power:	2000 VA / AC1
Peak current:	10 A / <3 s
Switching voltage:	250 V AC1
Mechanical service life:	10 mill.
Electrical service life (AC1):	100 thousand
Control	
Application protocol:	Matter
Communication protocol:	THREAD
Method of signal transmission	MESH
Frequency:	2.4 GHz
Manual control:	button PROG (ON/OFF)
External button / switch:	yes, opposite the L terminal
Range:	in open space up to 200 m
Other data	
Operating temperature:	-15 to + 50 °C
Operating position:	any
Mounting:	free at lead-in wires
Protection:	IP40
Overvoltage category:	III.
Contamination degree:	2
Connection:	screwless terminals
Connecting conductor:	0.2-1.5 mm ² solid/fl exible
Dimensions:	43 x 44 x 22 mm
Weight:	45 g
Related standards:	EN 60730, EN 63044, EN 301489, EN 300328

Device description

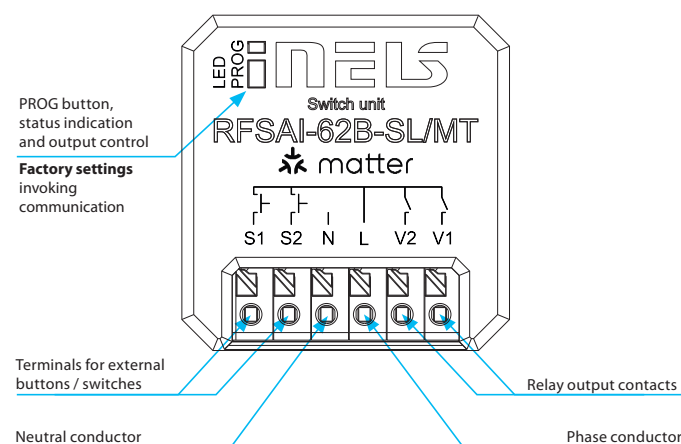

Connection

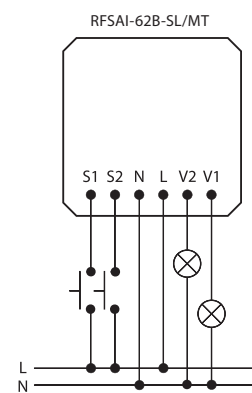

- Universal built-in dimmer is used to regulate light sources:
 - R – classic light bulbs,
 - L – halogen bulbs with wound transformer,
 - C – halogen bulbs with electronic transformer,
 - ESL – dimmable energy saving lamps,
 - LED – LED light sources (230 V).
- The Thread protocol guarantees compatibility with other products with the Matter support.
- Control input "S" for connection of the existing wired pushbutton.
- The programming pushbutton on the element can also be used as manual control of the output.
- The applicable reach is up to 200m (in free area).
- The BOX design offers installation directly in the junction box, soffit or cover of the light fitting.
- The element with the controller can be paired through a border router supporting Matter and through an application supporting Matter. The border router is understood as equipment such as HomePod Mini, Google Nest Hub or Samsung SmartThings Station.

EAN code:
RFDEL-71B-SL: 8595188189552

Technical parameters	RFDEL-71B-SL/MT
Supply voltage:	230 V AC / 50 Hz
Supply voltage frequency:	50-60 Hz
Apparent power:	5 VA / $\cos \varphi = 0.1$
Dissipated power:	0.5 W
Supply voltage tolerance:	+10/-15%
Connection:	4-wire, with "NEUTRAL"
Output	
Dimmed load:	R, L, C, LED, ESL
Contactless:	2 x MOSFET
Load capacity:*	max. 300 W*
Control	
Application protocol:	Matter
Communication protocol:	THREAD
Signal transmission method:	MESH
Frequency:	2.4 GHz
Range:	up to 200 m
Manual control:	button PROG (ON/OFF)
External button / switch:	yes
Other data	
Operating temperature:	-15 to + 45 °C
Working position:	any
Mounting:	free at lead-in wires
Protection:	IP40
Overvoltage category:	III.
Contamination degree:	2
Connection:	screwless terminals
Connecting conductor:	0.2-1.5 mm ² solid/flexible
Dimensions:	43 x 44 x 22 mm
Weight:	30 g
Related standards:	EN 60730, EN 63044, EN 301489, EN 300328

The given value is for load R, see table p. 70

Types of connectable loads

R resistive	L inductive	C capacitive	ESL light bulbs	LED light bulbs

Device description

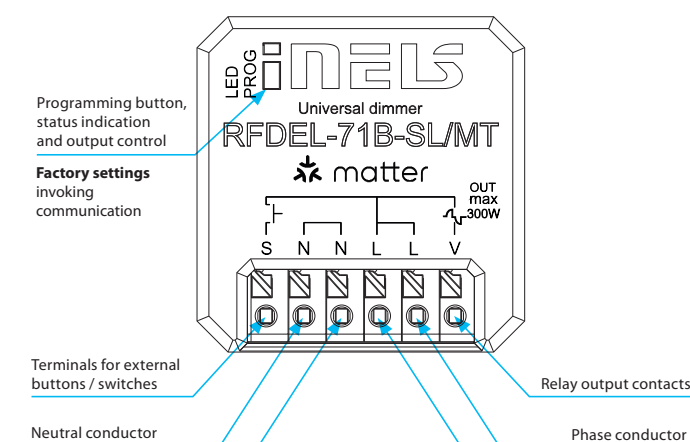

Connection

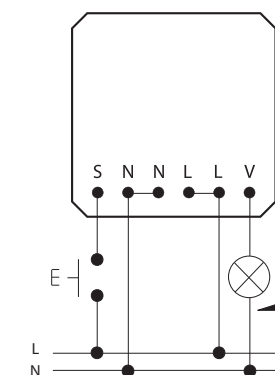



EAN code:
RFMD-200: 8595188191302

- The motion detector PIR is used to detect presence persons moving inside the building interior
- The Thread protocol guarantees compatibility with other products with the Matter support.
- Use:
 - in combination with a switching unit for automatic control of lighting or triggering an alarm
 - through the border router Matter, the detection can be displayed on your smartphone in the form of a notification
- Sensitivity settings of the PIR detector for eliminating unwanted triggering
- Power supply: 2x 1.5 V AA batteries, the battery life is around 1 year
- "Low Battery" Alerts by double LED flashing or on Matter app
- The Unit with the controller can be paired through a border router supporting Matter and through an application supporting Matter. The border router is understood as equipment such as HomePod Mini, Google Nest Hub or Samsung SmartThings Station.

Technical parameters	RFMD-200/MT
Power supply:	2x 1.5 V AA batteries
Battery life:	up to 1 year, according to the number of activations
Drained battery indicator:	yes
Control	
Application protokol:	Matter
Communication protocol:	THREAD
Frequency:	2,4 GHz
Repeater function:	no
Detection angle:	110°
Detection distance:	max. 9.5 m
Recommended working height:	max. 2.5 m
Other data	
Working temperature:	-10 to +50 °C
Protection:	IP20
Colour:	white
Dimension:	ø 95mm, height incl. lens 30mm
Weight:	113 g
Related standards:	EN 60730, EN 63044, EN 301489, EN 300 328

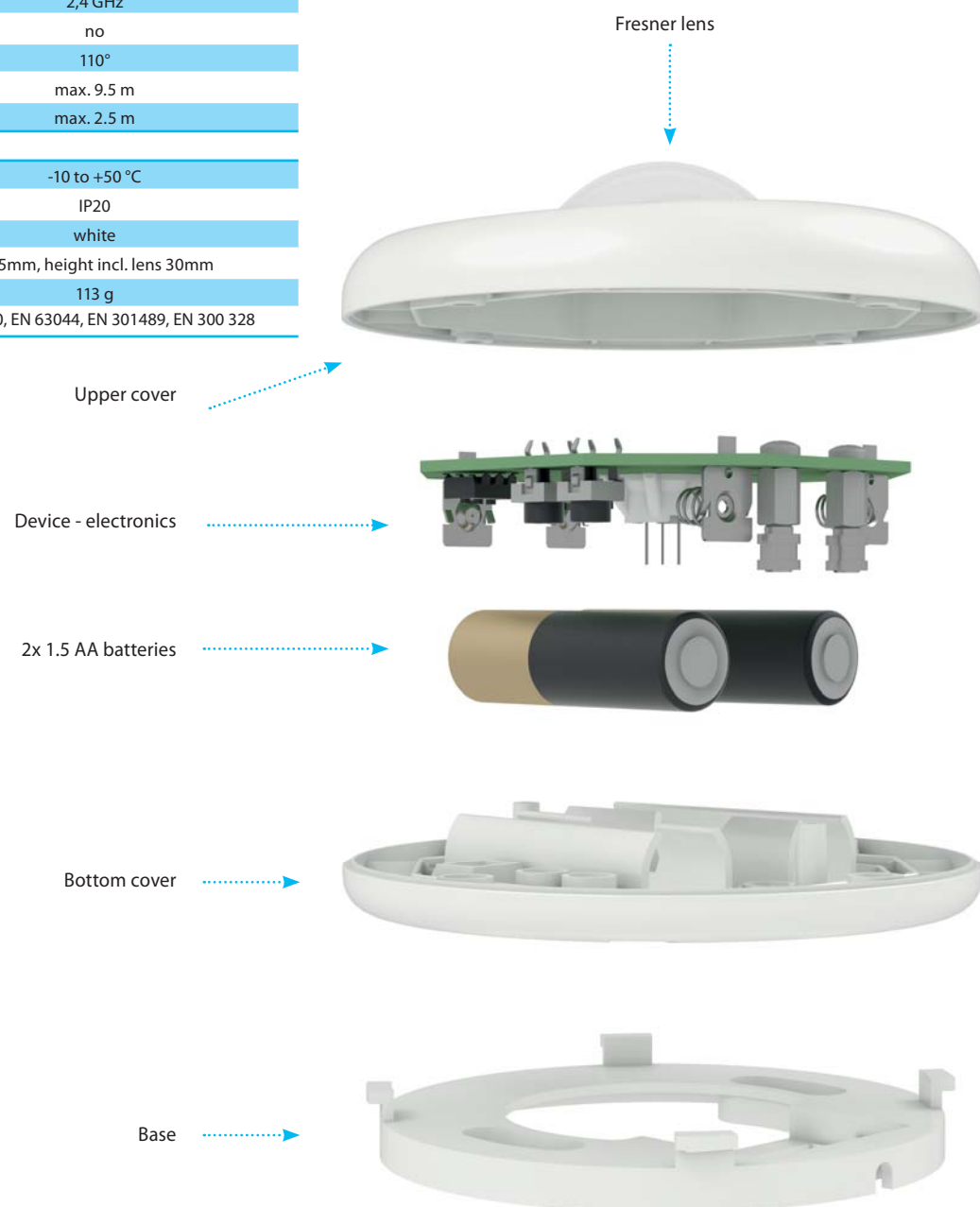

EAN code:
RFMD-100: 8595188189538

- The Window/Door detector is used to detect opening where activation occurs when the magnet and the sensor become separated
- It communicates on the Thread protocol that guarantees compatibility with other products with the Matter support
- Use:
 - in combination with the switching unit for automatic light control (cellar, garage, etc.)
 - by means of the Matter application, detection can be displayed on your smart phone in the form of a notification
- Power supply: 1x 3 V CR 2032 battery, the battery life is around 1 year
- Display of battery percentage in the form of Matter Application
- The pairing of the detector with the element is done via a border router supporting Matter and via a Matter-enabled application. Border router means a device such as a HomePod Mini, Google Nest Hub or Samsung SmartThings Station.

Technical parameters	RFWD-100/MT
Power supply:	1x 3 V CR 2032 battery
Battery life:	up to 1 year, according to the number of activations
Drained battery indicator:	yes
Control	
Application protocol:	Matter
Communication protocol:	THREAD
Frequency:	2,4 GHz
Detection angle:	105°
Other data	
Working temperature:	-10 to +50 °C
Protection:	IP20
Colour:	white
Dimension:	25 x 75 x 16 mm
Magnet dimension:	15 x 75 x 14 mm
Standards:	EN 60730, EN 63044, EN 301489, EN 300328



- In connection with the RFSW-62/S room unit (or RFTC-3 thermostat), it is used to signal the status of MUR, green LED and DND, red LED
- MUR and DND buttons are interlocked
- Also includes a bell button for controlling a room bell connected to the switched output of this unit or any iNELS Wireless switching element. The button has 2 colors of backlighting (explained below)
- The second switched output of this unit can be used to switch the in front door light and control it from the schedule HRS system, by time or intensity
- The unit can be mounted in an installation box, for example replace a bell button or light switch, only requires a 230V AC power supply. Communication is then wireless
- The unit can be controlled by up to 4 indoor units (RFSW-62/S or RFTC-3)
- Setup and programming is done by a pairing button + signaled by service LEDs
- The unit can be connected to the HRS (Hotel Reception Software) via the eLAN-RF gateway or the RFTC-3 thermostat. The functions can then be controlled from the reception PC console or the iNELS application.
- Standard glass colour white/black, room number and hotel logo can be defined when ordering

Technical parameters		RFGS-30/S
Supply voltage:	230 V AC / 50-60 Hz or 24 V AC / DC	
Apparent/loss power input:	1.1 VA / 0.8 W	
Supply voltage tolerance:	±10 %	
Output		
Relay:	2x switching / 8 A / 250 V AC1 / 2000 VA	
Peak Current:	I _{peak} <110A 300us / max. input capacitance 125 uF	
Contact Life:	mechanical 10 mil. / electrical 100,000 cycles	
Control		
Number of Buttons:	1	
Communication:	RFIO2	
Frequency:	866-922 MHz (more on page 81)	
Repeater Function:	yes	
Range:	in open areas up to 200 m	
Connection		
Terminal block:	screwless - push in	
Wire gauge:	0.2 - 1.5 mm ² solid flexible	
Other data		
Operating Temperature:	-10 to +50 °C	
Storage temperature:	-30 to +70 °C	
Enclosure:	front IP60 / rear IP20	
Overvoltage Category:	II.	
Pollution Degree:	2	
Working position:	Any	
Installation:	in to the installation box	
Dimension:	94 x 94 x 39 mm	
Weight:	128 g	
EAN for 230 V, WHITE, SHARP:	RFGS-30/SW/230: 8595188189477	
EAN for 230 V, BLACK, SHARP:	RFGS-30/SB/230: 8595188189200	
EAN for 24 V, WHITE, SHARP:	RFGS-30/SW/24: 8595188191586	
EAN for 24 V, BLACK, SHARP:	RFGS-30/SB/24: 8595188191579	
Related standards:	EN 60730, EN 63044, EN 301489, EN 300 220	

Create your glass design here:
icons.inels.com

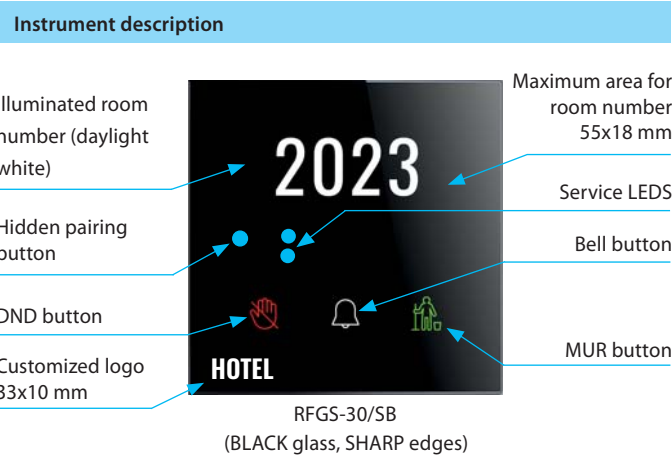
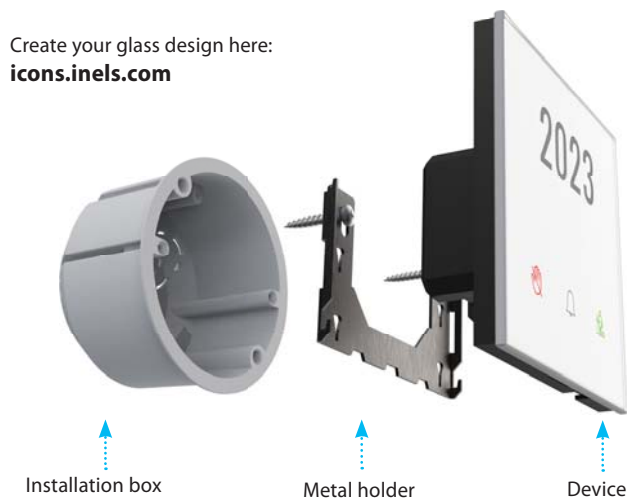

- Button legend**
- MUR GREEN backlight Make Up Room
 - DND RED backlight Do not Disturb
 - Bell BLUE backlight Bell

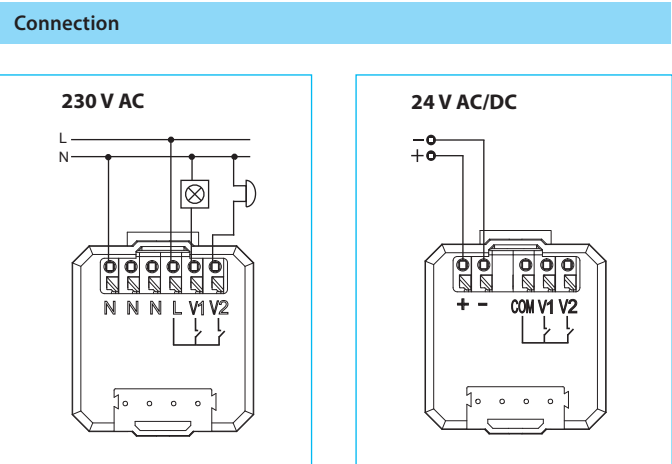

BELL button backlight meaning			
	Colour	Room	Ring
	White	vacant	YES
	Blue	occupied	YES
	Blue+DND active	occupied, but „Do not disturb“	NO

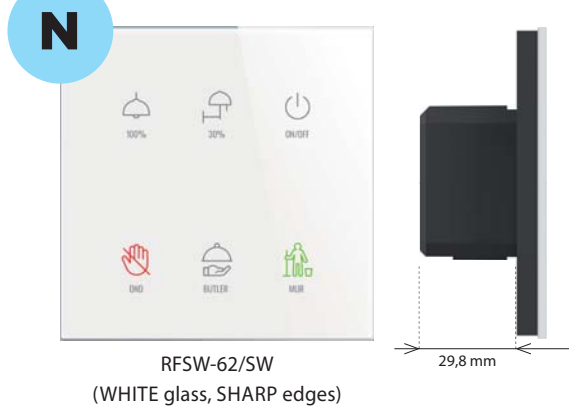

Technical parameters		RFSW-62/S
Supply voltage:	230 V AC / 50-60 Hz or 24 V AC / DC	
Apparent/loss power input:	1.1 VA / 0.8 W	
Supply voltage tolerance:	±10 %	
Output		
Relay:	2x switching / 8 A / 250 V AC1 / 2000 VA	
Peak Current:	I _{peak} <110A 300us / max. input capacitance 125 uF	
Contact Life:	mechanical 10 mil. / electrical 100,000 cycles	
Control		
Number of Buttons:	6	
Communication:	wireless, iNELS RFIO2 protocol	
Frequency:	866-922 MHz (more on page 81)	
Repeater Function:	yes	
Range:	in open areas up to 200 m	
Connection		
Terminal block:	screwless - push in	
Wire gauge:	0.2 - 1.5 mm ² solid flexible	
Other data		
Operating Temperature:	-10 to +50 °C	
Storage temperature:	-30 to +70 °C	
Enclosure:	front IP60 / rear IP20	
Overvoltage Category:	II.	
Pollution Degree:	2	
Working position:	Any	
Installation:	in to the installation box	
Dimension:	94 x 94 x 39 mm	
Weight:	131 g	
EAN for 230 V, WHITE, SHARP:	RFSW-62/SW/230: 8595188189484	
EAN for 230 V, BLACK, SHARP:	RFSW-62/SB/230: 8595188189255	
EAN for 24 V, WHITE, SHARP:	RFSW-62/SW/24: 8595188191289	
EAN for 24 V, BLACK, SHARP:	RFSW-62/SB/24: 8595188191296	
Related standards:	EN 60730, EN 63044, EN 301489, EN 300 220	

Create your glass design here:
icons.inels.com



- The wireless glass remote control with symbols is used for:
- Control of iNELS Wireless elements (lighting, blinds or curtains)
- Control of the RFGS-30/S front door unit for MUR/DND
- Switching of 2x light circuits
- MUR (Make Up Room, green LED) and DND (Do not Disturb, red LED) buttons are interlocked
- Butler button calls hotel service (set in HRS)
- the top 3 buttons can be freely defined to control local outputs of the unit or any iNELS Wireless element located in the room (switching, dimming, HVAC, shading)
- Setup and programming is done by pairing button + signaling by service LEDs
- The unit can be connected to the HRS (Hotel Reception Software) system via eLAN-RF gateway or RFTC-3 thermostat. The functions can then be controlled from the reception PC console or the iNELS application of the phone.
- Standard glass colour white/black, buttons and descriptions at the top - or hotel logo when ordering

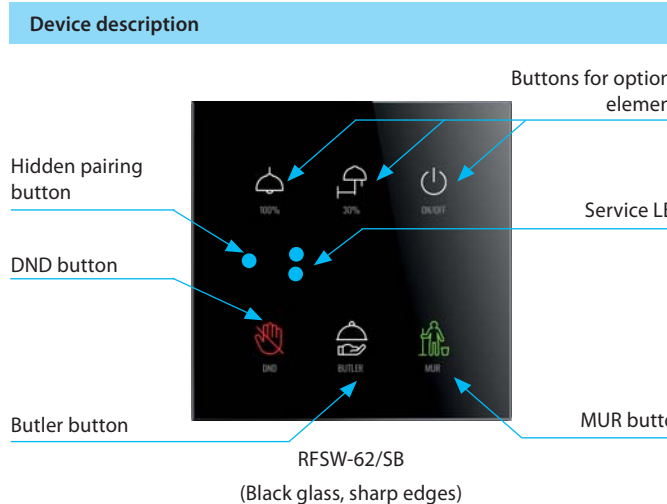

- Legend of buttons**
- MUR GREEN backlight Make Up Room
 - DND RED backlight Do not Disturb
 - Butler WHITE backlight Hotel service
 - Buttons for optional elements WHITE backlight Buttons for optional elements

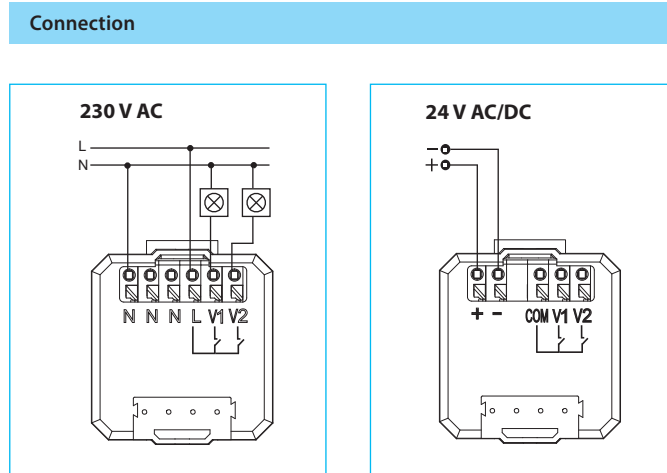

ZERO CROSS Friendly Light switching
The output contacts (V1, V2) are galvanically isolated from the power supply and are equipped with zero cross switching technology



EAN code:
RFS-266M: 8595188189781

Technical parameters		RFS-266M/230V
Supply voltage:	110–230 V AC	
Supply voltage frequency:	50–60 Hz	
Apparent input:	min. 2 VA/max. 5 VA	
Dissipated power:	min. 0.5 W/max. 2.5 W	
Supply voltage tolerance:	+10%/-25 %	
Output		
Number of contacts:	5x switching (AgSnO ₂) / 7 A/AC1 / 10 A/<3 s	
Switching power:	1750 VA/AC1	
Switching voltage:	250 V AC1	
Mech. / el. service life (AC1):	5x 10 ⁶ / 6x10 ⁴	
Analog output	2x 0 – 10V (OUT1, OUT2)	
Input		
Analog	YES, 2x terminals INT1/GND, INT2/GND / 2x NTC 12 ICR (TC/TZ sensor)	
Control		
Communication protocol:	RFIO2, MODBUS, WIFI, MQTT	
Frequency:	866–922 MHz (for more info see p. 81)	
Repeater function:	yes	
Range:	in open space up to 160 m - RFS-66MI	
Other data		
Operating temperature:	-15 °C to +50 °C	
Operating position:	any	
Mounting:	DIN rail EN 60715	
Protection:	IP20 from the front panel	
Overvoltage category:	III.	
Contamination degree:	2	
Connecting conductor	max. 1x 2.5, max. 2x 1.5/ with a hollow max. 1x 2.5	
cross-section (mm ²):	with a hollow max. 1x 2.5	
Dimensions:	90 x 52 x 65 mm	
Weight:	264 g	
Related standards:	EN 60730, EN 63044, EN 300 220, EN 301 489	

- Thanks to the 5-channel design of the switching component it can control the heating/cooling mode and 3 speed levels.
- The RFS-266M wireless switch unit can be combined with the RFTC-4.
- The input channels are used to connect to external TC/TZ temperature sensor.
- The product is independently functional when connected to the MODBUS, otherwise it must be connected to control element, e.g. RFTC-4.
- Support for both 2-pipe fancoil and 4-pipe fancoil.
- Fancoil controls the cooling or heating of the room and provides up to 3 speed levels.
- In case of insufficient signal between the controller and the switch unit, use the signal repeater RFRP-20N or elements with RFIO2 protocol that support this function.

Connection for fancoil control

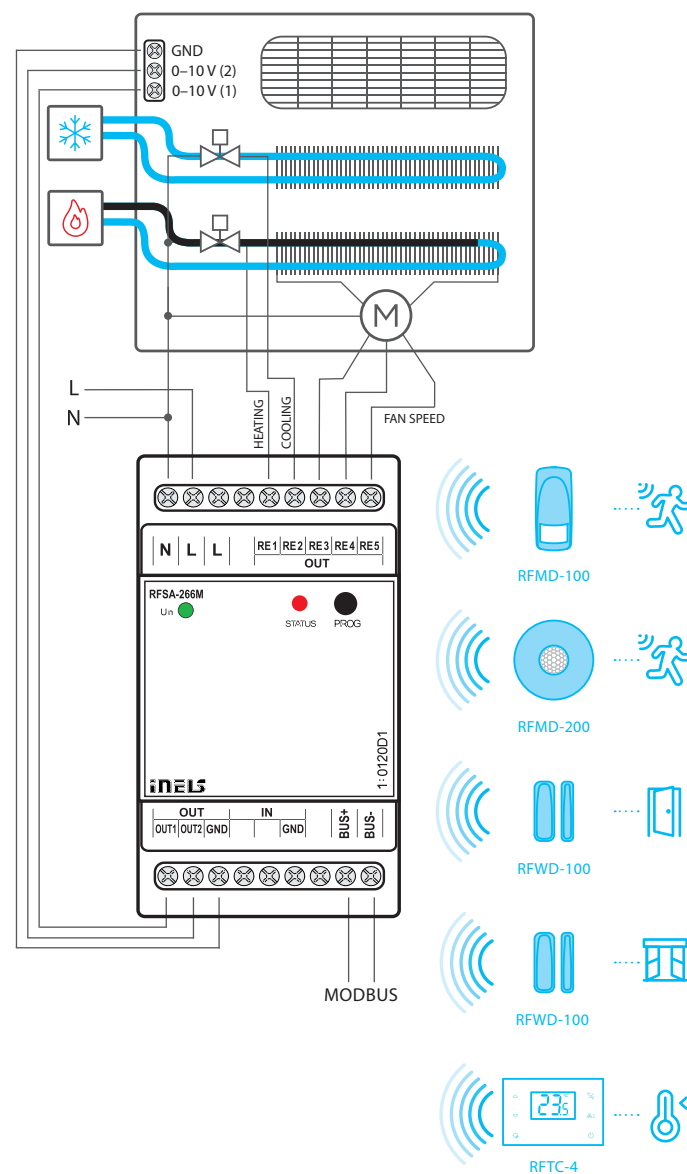

EAN code:
RFS-161B: 8595188149341

Technical parameters		RFS-161B/230V	RFS-161B/120V
Supply voltage:	230 V AC		120 V AC
Supply voltage frequency:	50–60 Hz		60 Hz
Apparent power:	9 VA		9 VA
Dissipated power:	0.7 W		
Supply voltage tolerance:	+10 %; -15 %		
Output			
Number of contacts:	1x switching (AgSnO ₂)		
Rated current:	12 A/AC1		
Switching power:	3000 VA/AC1, 288 W/DC		
Peak current:	30 A, max. 4 s at 10%		
Switching voltage:	250 V AC1/24 V DC		
Min. switching power DC:	100 mA/10 V		
Insulation voltage between outputs and internal circuits:	basic insulation (Cat. III surges by EN 60664-1)		
Isolation voltage open contact:	1 kV		
Mechanical service life:	3x10 ⁷		
Electrical service life (AC1):	5x10 ⁴		
Indication of relay switch:	red LED		
Control			
Communication protocol:	RFIO2		
Frequency:	866–922 MHz (for more information see p. 81)		
Repeater button:	yes		
Manual control:	button PROG (ON/OFF)		
External button:	cable length max. 12 m Δ *		
Range:	in open space up to 160 m		
Other data			
Open contact voltage external switch:	3 V		
Resistor for the management of external switch:	<1 k Ω		
Resist. of connection for open contact:	>10 k Ω		
Galvanic isolation of input:	no		
Operating temperature:	-15 to +50 °C		
Storage temperature:	-30 to +70 °C		
Working position:	any		
Mounting:	free at lead-in wires		
Protection:	IP30		
Overvoltage category:	III.		
Contamination degree:	2		
Terminals:	0.5–1 mm ²		
Terminals (CY wire, Cross-section):	2x 0.75 mm ² , 2x 2.5 mm ²		
Terminal length:	90 mm		
Dimensions:	49 x 49 x 21 mm		
Weight:	50 g		

* We recommend using a twisted pair cable for this distance. Control button input is at the supply voltage potential.

- Switch component with one output channel which is used in combination with detectors for automatic lighting control.
- RFS-161B has a pre-set control algorithm (scene) adapted to the requirements of hotel room control, see wiring.
- Each RFS-161B can be programmed with 1x RFMD-100, 1x RFRD-100 and 1x wireless controller (RFRB-40/G or RF KEY).
- The terminals on the component give you the opportunity to connect a wired detector or an existing key installation.
- It enables connection of the switched load up to 1x 12 A (3000 VA).
- The programming button on the unit is also used for manual control of the output.
- Range up to 160 m (in open space), if the signal is insufficient between the controller and unit, use the signal repeater RFRP-20N or protocol component RFIO2 that support this feature.

Device description

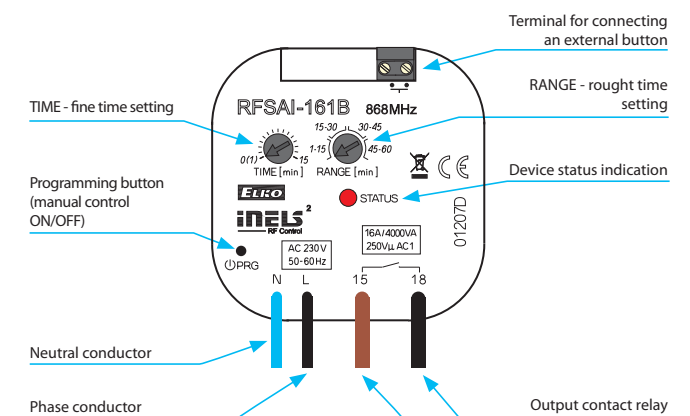

Compatible wireless detectors:
Movement: RFMD-100
Door/Window: RFRD-100

Connection

RFS-161B/230V
RFS-161B/120V

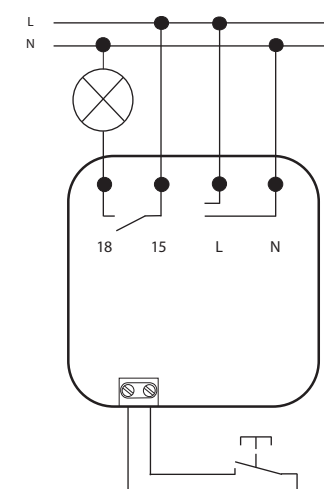

Example

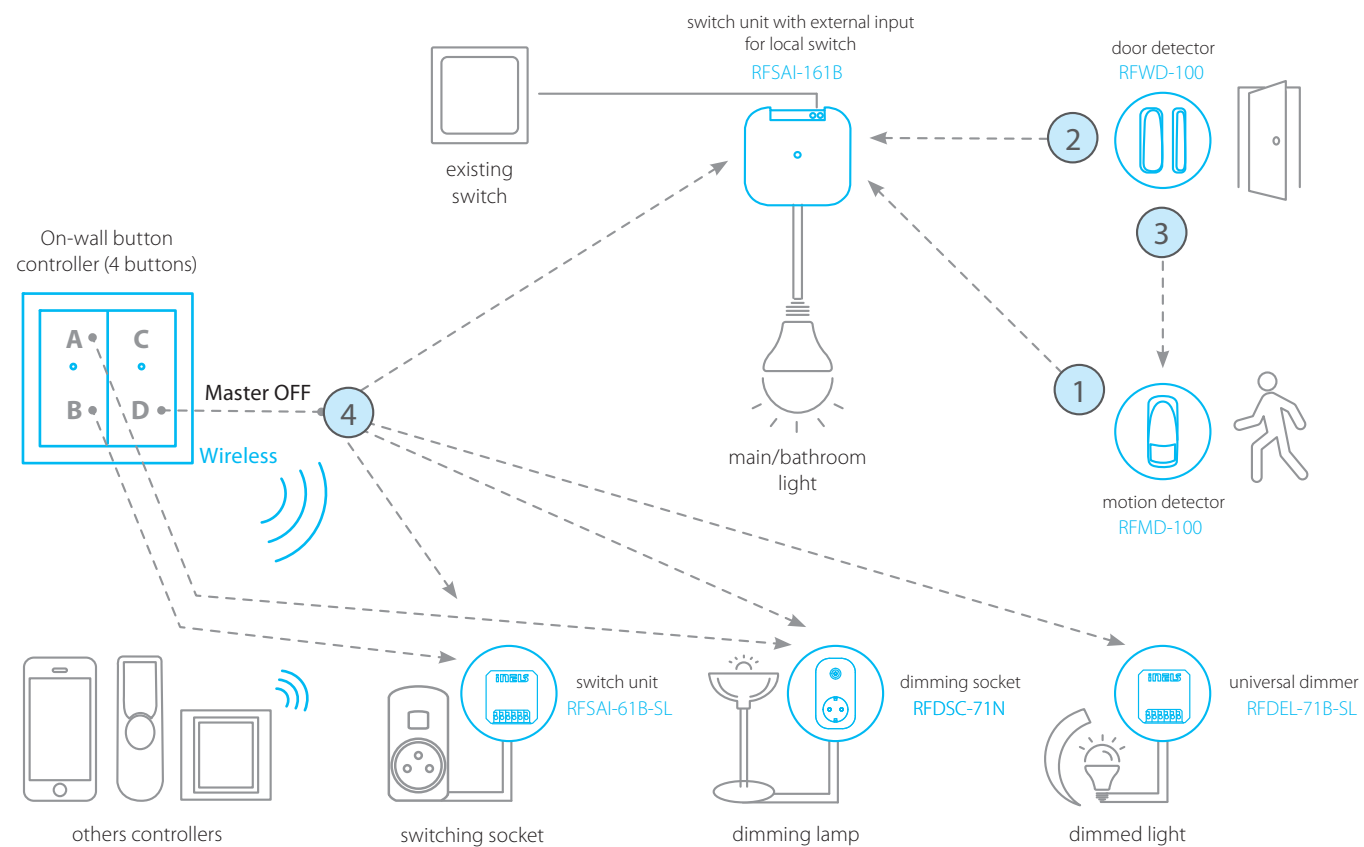

Function

- When RFMD-100 motion detector captures the movement of the guest, the light ON command is sent.
- The functionality of RFWD-100 door detector is delayed OFF= after the guest (or cleaner) close the door than the timer starts running (which you can set) and the light will turn OFF.
- If there is movement the command from RFWD-100 door detector (delay off) will be cancelled by the motion detector RFMD-100 command.
- Pressing the button at position D of RFWB-40 On-wall button controller sends an OFF command to all components that are controlled from that button while blocking the response to RFMD-100 motion detector.
- You are able to control other units with other channels (A, B, C) on RFWB-40 On-wall button controller.
- When guest wakes up and presses any RFWB-40 button, then pressing on button makes all units working again after previous pressing button on position D and it also re-enable RFMD-100 motion detector primary function.



EAN code:
RFSTI-111B: 8595188149150

Technical parameters	RFSTI-111B/230V	RFSTI-111B/120V
Supply voltage:	230 V AC	120 V AC
Supply voltage frequency:	50-60 Hz	60 Hz
Apparent input:	9 VA/cos φ=0.1	9 VA/cos φ=0.1.
Dissipated power:	0.7 W	
Supply voltage tolerance:	+10 %; -15 %	
Temperature measurement input:	1x external TZ/TC temperature sensor input [⚠]	
Temp. measurement range and accuracy:	+15 to +35 °C; 0.5 °C of the range	
Output		
Number of contacts:	1x switching (AgSnO ₂)	
Rated current:	12 A/AC1	
Switching power:	3000 VA/AC1, 288 W/DC	
Peak current:	30 A/max. 4 s at 10%	
Switching voltage:	250 V AC1/24 V DC	
Min. switching power:	100 mA/10 V	
Insulation voltage between relay outputs and internal circuits:	basic insulation (Cat. III surges by EN 60664-1)	
Isolates. voltage open relay contact:	1 kV	
Mechanical service life:	3x10 ⁷	
Electrical service life (AC1):	5x10 ⁴	
Control		
Communication protocol:	RFIO2	
Frequency:	866-922 MHz (for more information see p. 81)	
Repeater function:	yes	
Range:	in open space up to 160 m	
Other data		
Operating temperature:	-15 to +50 °C	
Storage temperature:	-30 to +70 °C	
Indication of relay switch:	red LED	
Indication regulation:	green LED	
Operating position:	any	
Mounting:	free at lead-in wires	
Protection:	IP30	
Overvoltage category:	III.	
Contamination degree:	2	
Outlets (CY wire, cross-section, length):	2 x 0.75 mm ² , 2 x 2.5 mm ² , 90 mm	
Dimensions:	49 x 49 x 21 mm	
Weight:	50 g	
Related standards:	EN 60730, EN 63044, EN 301489, EN 300 220	

[⚠] Temperature sensor input is at the supply voltage potential.

- The component measures temperature in the range of 15 to 35 °C with external sensor and on the basis of the set temperature switches air conditioning.
- It is particularly suitable for hotel rooms.
- With the Window/Door sensor programmed, when the window/door is opened, the device relay contact is automatically disconnected, there by saving unnecessary energy consumed for cooling when the window/door is open.
- It enables connection of the switched load up to 12 A (3000 VA).
- Up to 4 RFWD-100 detectors can be connected to one RFSTI-111B device.
- Range up to 160 m (in open space), if the signal is insufficient between the controller and unit, use the signal repeater RFRP-20N or protocol component RFIO2 that support this feature.
- The BOX design lets you mount it right in an installation box, a ceiling or controlled appliance cover.
- External sensor TC (-20 to +80 °C) or TZ (-40 to +125 °C) for length of 3 m, 6 m, 12 m. For more information see „Accessories“ on page 45.

Device description

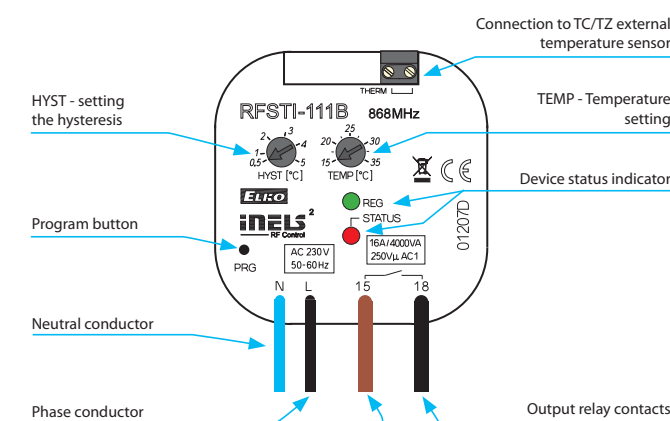

Function

The external sensor senses the temperature of the room, turns the air conditioner on and off according to the set temperature. Responds to commands from the detector - when you open the window, turn off air conditioning.

Connection

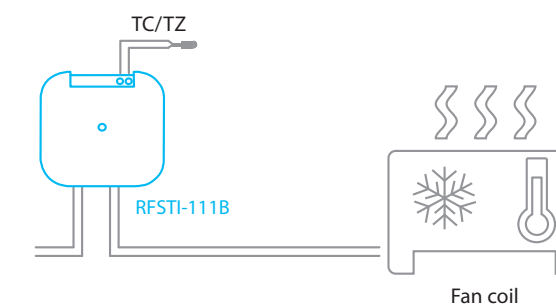

Accessories

AN-I | Internal antenna



EAN code:
AN-I: 8595188161862

Technical parameters	AN-I
Polarization:	vertical
Gain:	2.1 dBi
Dimensions:	17 x 44 x 8.5 mm
Impedance:	50 Ω
Colour:	black

The rod antenna with SMA connector is supplied as standard with the product.

Extension cable for external antenna



10 m

AN-I antenna measurement graph

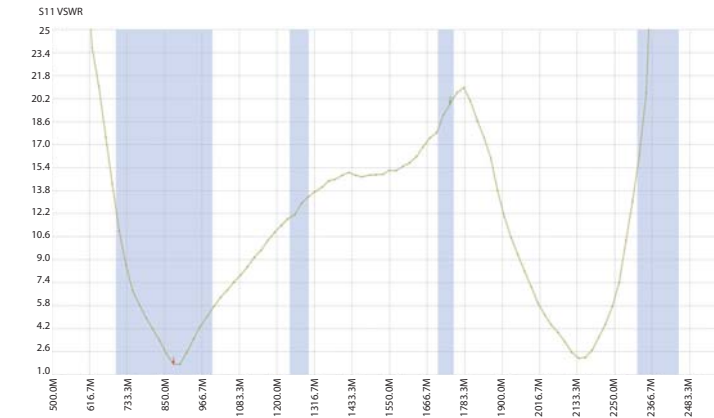

- The internal antenna is included in the standard package.

Technical parameters

Connector Type:	SMA (male/female)
Colour:	white
Cable Length:	10 m

Measured range between controllers and RFSA-66M

	RFGB	RFWB	RF KEY
AN-I	305 m	290 m	190 m
AN-E	300 m	290 m	200 m
AN-E3	275 m	260 m	180 m

The range is measured with direct visibility between the RFGB-x, RFWB-x, RF KEY and RFSA-66M actuators.
Connecting the antenna extension cable does not affect the range.

RFAF/USB | Service Key

Technical parameters	RFAF/USB
Power:	max. 1 W
Interface:	USB 1.1 and higher, plug „A“
Range:	100 m
Min. distance of RF Touch-Actuator:	1 m
Communication protocol:	RFIO2
Frequency:	866–922 MHz (for more information see p. 81)
Power supply indication:	green LED
communication indication:	red LED
Other data	
Operating temperature:	0 to +55 °C
Storage temperature:	- 20 to +70 °C
Protection:	IP30
Contamination degree:	2
Work space:	any
Installation:	any
Dimensions:	22 x 85 x 15 mm
Weight:	20 g
Related standards:	EN 60730, EN 63044, EN 300 220, EN 301 489



EAN code:
RFAF/USB: 8595188145039

- The RFAF/USB Service Key (in conjunction with the Wireless_analyzer) is designed for iNELS Wireless Control system partners and serves for:
 - Setting the repeater (signal amplifier) through the iNELS Wireless Control elements labeled as RFIO2. This option allows you to communicate over longer distances (in the order of 50 m) via existing iNELS Wireless elements in the installation (eliminating the use of the RFRP-20N repeater).
 - upgrade of firmware in the iNELS Wireless elements (labeled RFIO2), in the case of new firmware versions that improve the functionality of the elements on which we are constantly working.
 - The Wireless Network Analyzer will reliably analyze the communication between the controller (where you plan to place it) and the component in the installation. Indicates signal strength/quatty as well as possible frequencies that can interfere with communication.
 - SW Wireless analyzer can be found at inels.com/partners in section SW/FW Wireless Control

AN-E1 | External antenna



AN-E antenna measurement graph

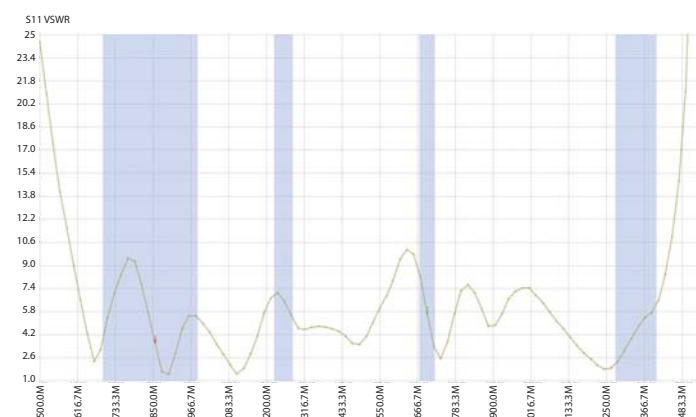

EAN code:
AN-E1: 8595188190121

Technical parameters		AN-E1
Mounting:	Magnetic Mount	
Cable Length:	3 m	
Polarization:	vertical	
Gain:	5 dBi	
Impedance:	50 Ω	
Colour:	black	
Dimensions:	Ø 30 x 280 mm	

AN-E3 | External antenna



3 m

AN-E3 antenna measurement graph

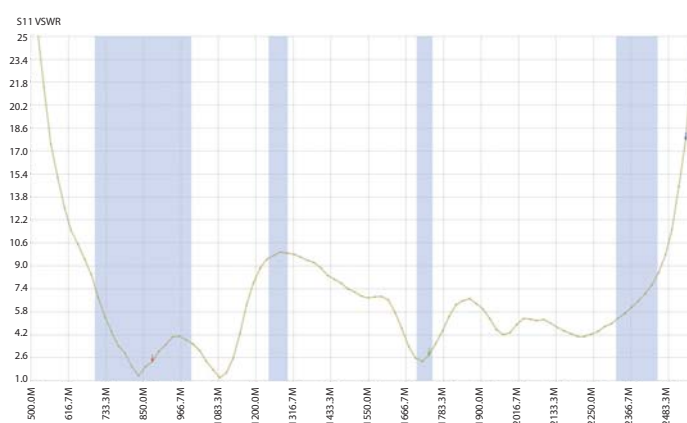

EAN code:
AN-E3: 8595188190121

Technical parameters		AN-E3
Cable Length:	3 m	
Polarization:	vertical	
Gain:	3 dBi	
Impedance:	50 Ω	
Colour:	black	
Dimensions:	Ø 50 x 88 mm	

- The external antenna is intended for outdoor use.

MS | Magnetic sensor



- The LED sensor scans LED impulses on the meter, which indicates consumption by flashing.
- The LED sensor is particularly suitable for power meters that support LED pulse sensing (the LED on the meter is marked "imp").
- The sensor's scanner is affixed with glue above the LED diode of the meter signaling indication of consumption.
- The sensor is connected to the internal terminal of the RFTM-1 converter.

Technical parameters	MS
Voltage range:	1.6 to 3.6 V
Consumption	7uA *
Output load:	max. 3mA
Scanning period:	100ms
Switch sensing sensitivity (output L):	±(2.3 to 4.7)mT
Opening detection sensitivity (output->H):	±(0.9 to 3.8)mT
Hysteresis:	1mT
Working temperature:	-40 to 80 °C
Other data	
Cross-section of connecting wires:	max. 3.5 mm
Wire length:	1.5 m
Protection:	IP20

LS | LED sensor



- The LED sensor scans LED impulses on the meter, which indicates consumption by flashing.
- The LED sensor is particularly suitable for power meters that support LED pulse sensing (the LED on the meter is marked "imp").
- The sensor's scanner is affixed with glue above the LED diode of the meter signaling indication of consumption.
- The sensor is connected to the internal terminal of the RFTM-1 converter.

Technical parameters	LS
Voltage range:	2.5 to 3.7V
Minimum consumption (idle mode):	0.5uA *
Maximum power consumption (pulses 100Hz):	max. 2uA *
Working temperature:	-20 to 50 °C
Other data	
Cross-section of connecting wires:	max. 3.5 mm
Wire length:	1.5 m
Protection:	IP20

Sensor LS responds only to light pulses, i.e. it does not detect static state LEDs.

WS | Magnetic sensor for water meter



- A magnetic sensor that detects the pulse that is created by each rotation of the magnet placed on the unit dial meter.
- The WS sensor is especially suitable for water meters that support magnetic sensing.
- The sensing sensor is glued over the circular unit face of the gauge (the scanning dial is different from the other indicators, e.g. the white arrow wheel).
- The sensor is connected to the internal terminal of the RFTM-1 converter.

Technical parameters	WS
Voltage range:	1.65 to 5.5V
Consumption:	1.5uA *
Output load:	max. 150uA
Switch sensing sensitivity:	±(0.3 to 1.1)mT
Opening detection sensitivity:	±(0.2 to 0.9)mT
Hysteresis:	0.2mT
Working temperature:	-40 to 80 °C
Other data	
Cross-section of connecting wires:	max. 3.5 mm
Wire length:	1.5 m
Protection:	IP20

* Measured at 3V, no load output.

Smartphones



- Control application for smartphones and tablets with Android and iPhone operating systems - iHC-AiO. It allows you to easily control your house.
- The user-friendly and intuitive application environment offers central control from one place.
- The application enables control of the complete iNELS Wireless and BUS solution via the Smart RF gate, Connection server, Central unit and other supported third-party devices that are connected to the home Internet network.
- The application allows free remote control.
- IHC-AiO features:
 - unification of all iNELS devices under one application. Specifically, eLAN RF 003, eLAN RF 103, eLAN IR, CU3, CS and LARA
 - within BUS it is now possible to configure rooms without the need for a public server or CS
 - user management - in the application it will be possible to set rights for all users who will use one system
 - automation - creation of conditions within Wireless, BUS systems or in both systems
 - low battery notification, alarms, actuator status
 - history of states of individual actors
 - display of all added devices in a clear menu and the possibility of configuring your own dashboard.

Manual:



Overview

Absolute control over the state of all technologies.

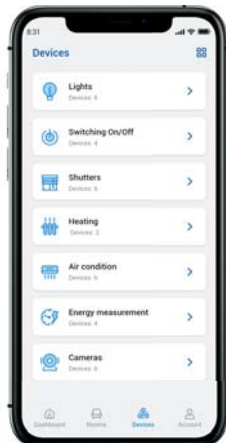

Device list

Control the device from anywhere.

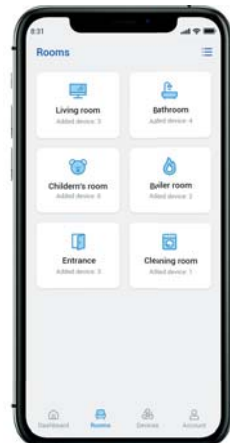

Rooms management

Settings according to individual rooms.



Colour setting

Easy adjustment of the light scene with one touch - switching, dimming, colour.

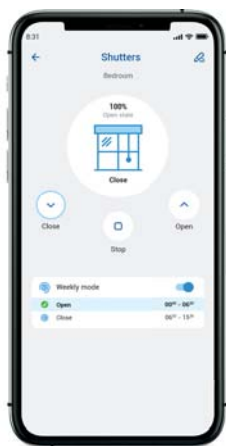

Shutters/Blinds

Possibility of individual or joint control of shading technology.



Temperature

You can set the temperature in each room exactly as you like.

Smart TV



- Device control via Smart TV is possible not only in the wireless installation of iNELS Wireless Control using the smart box eLAN-RF, but also in the case of wired option iNELS BUS using the Connection server. The iHC-SMTV app is free to download from the app store on your Smart TV.
- The control of app works with a classic TV remote control.
- Every Smart TV that has been manufactured since 2015 and supports OS Tizen is compatible.
- Functionality:
 - ON/OFF switching, with the possibility of time schedules
 - dimming ON/OFF, smooth brightening/dimming, color change
 - scenes
 - heating (temperature correction, heating mode change, cooling/heating mode)
 - cameras (image, or live stream if supported by web browser on Smart TV).
- iHC-SMTV (Smart TV App) is free and is not licensed in any way.
- Here you will find a link to the application:

Download:

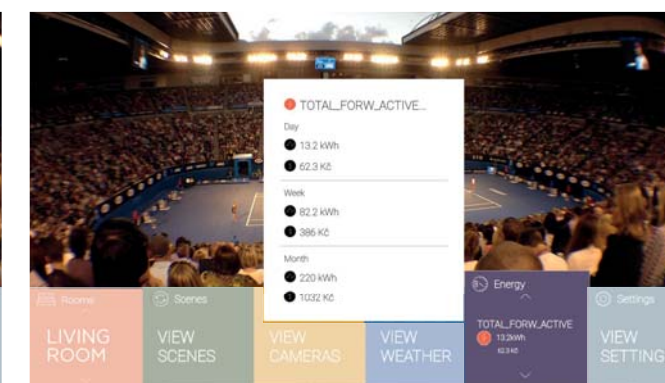
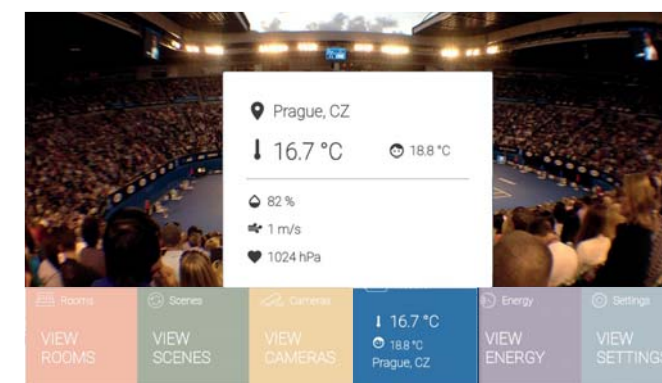
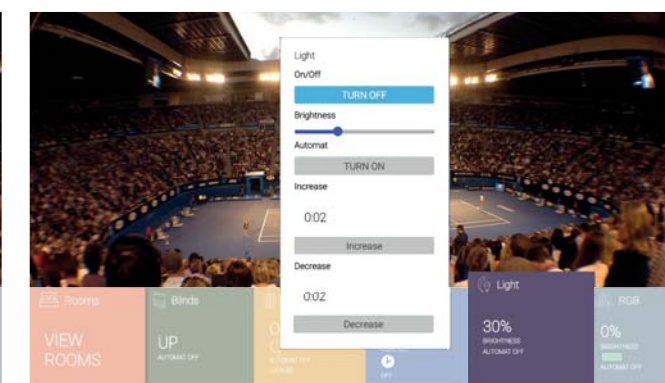
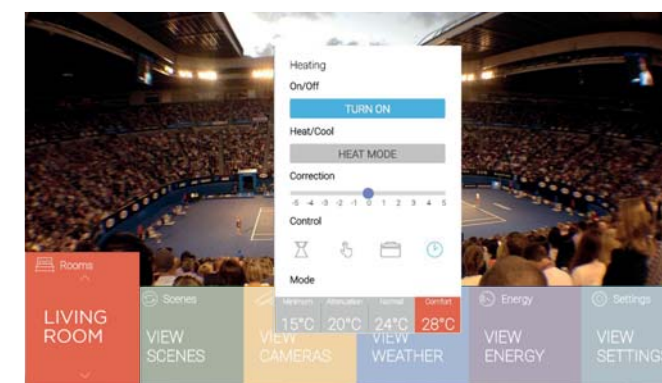
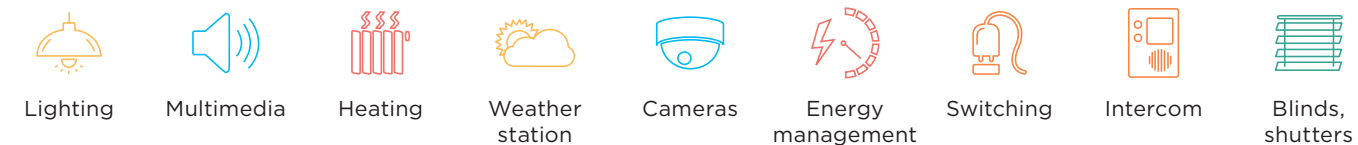

Amazon Alexa



- With Alexa Artificial Intelligence, you can simplify your daily life by setting an alarm, notifications, creating new items, or reminders in your calendar.
- The voice assistant can answer questions and control individual devices and smart homes.
- It is available on mobile phones, TVs, smart speakers and other devices.
- The voice assistant is designed to comfortably control the Wireless Control wiring by voice using your mobile phone or smart speaker.
- As a complement to Wireless Control, iNELS Smart Home Solution blends in with every modern home.
- Here you will find a link to the manual:



EN

Google Home



- Google Home can become a member of your smart home family.
- It communicates with the smart eLAN-RF box via the Cloud connection.
- This allows you to control, for example, the temperature setting or the light intensity by voice.
- The voice assistant is designed to conveniently control the Wireless Controlled electro-installations by voice using your mobile phone or smart speaker.
- As a complement to Wireless Control, iNELS Smart Home Solution blends in with every modern home.
- Here you will find a link to the manual:



EN

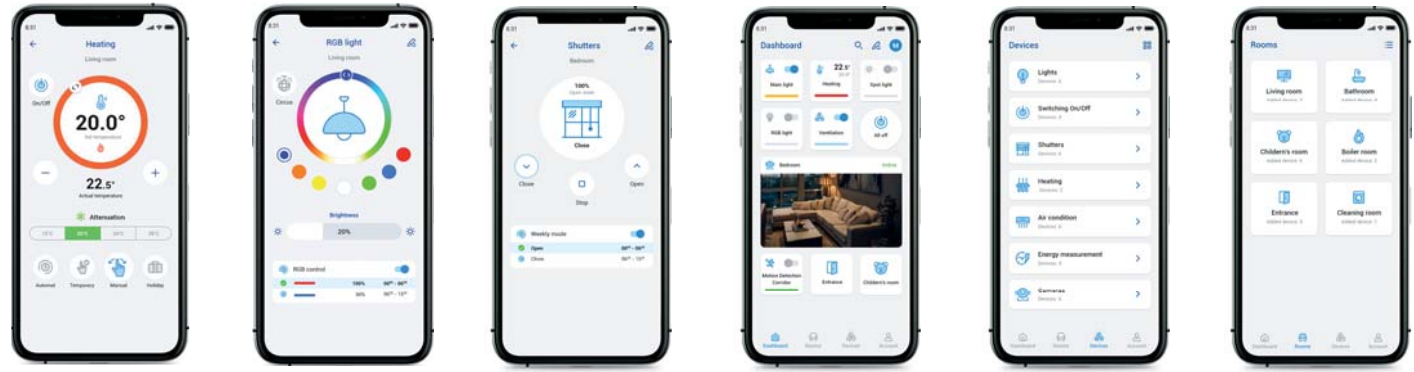

New mobile app for controlling all compatible elements from the iNELS portfolio.

Application iNELS:

- Designed for iOS 11+ and Android 7.0+.
- Optimized for devices with 1 024 x 768 screen resolution.
- The language of the application changes automatically according to the language set in Android/iOS.
- You can create a cloud account on the login screen in the app. The recommended minimum speed for connecting the eLAN-RF to the Cloud should be in the order of megabytes per second (3G - 1Mbit/s and higher).

The communication between the components is wireless at 866–922 MHz (according to country standards/regulations), using the unique RFIO and RFIO2 protocols. Both are proprietary wireless protocols from ELKO EP, which have a completely unique structure. RFIO2 is an extension of the RFIO protocol and allows users to use newly introduced features, such as unit signals (repeater), for selected features. This protocol is fully compatible with the previous version of the protocol (RFIO).

Available frequency for individual territories:

865.15 MHz India	916 MHz Australia, New Zealand, America, Israel
868.1 MHz Russia	
868.5 MHz EU, Ukraine, Middle East	

- Benefits of RFIO:**
- Communication is low-energy and reliably transfers small data packets.
 - Fees or licenses are not required.
 - No overlapping of communication space with unaddressed commands.
 - Frequency used does not interfere with Wi-Fi/Bluetooth devices.
 - Setting communication between components is not conditional on working with a computer or system.

- Benefits of RFIO2:**
- Products labeled as "RFIO2" will allow newly set selected components such as unit signals (repeaters).
 - For components, you can easily update FW using the RFAF/USB service device.
 - Enables communication with RFMD-100 and RFWD-100.
 - Data transfer between wireless components takes place in such a way that other receivers within range can help transfer the information (packet) to a remote receiver that is out of reach. It is possible to cover large-scale objects (real estate) and also increase the reliability of transmission in more demanding buildings.
 - Backward compatibility with RFIO elements is retained.

Problematic choice of suitable relay contact for a particular load switched with a product is described below. Mostly we experience problems with incorrect choice of load (meaning incorrect relay for a particular load) which results in permanent switching of contact (sealing) or damage on relay contact – which then results in malfunction. What load can you use? Detailed types of load according to standard EN 60947 are described in charts below – categories of use.

Category of use	Typical use	EN
AC current, $\cos\phi = P/S$ (-)		
AC-1	Non-inductive or slightly inductive load, resistance furnace Includes all appliances supplied by AC current with power factor ($\cos\phi$) ≥ 0.95 Examples of usage: resistance furnace, industrial loads	60947-4
AC-2	Motors with slip-ring armature, switching off	60947
AC-3	Motors with short-circuit armature, motor switching when in operation This category applies to switching off motors with short-circuit armature while in operation. While switching, contactor switches current which is 5 up to 7 times rated current of motor.	60947-4
AC-4	Electro-motors with short-circuit armature: start up, braking by backset, changeover	60947
AC-5a	Switching of electrical gas-filled lights, fluorescent lights	60947-4
AC-5b	El. bulb switching Enables low contact loading due to resistance of cold fiber is many times smaller than the one of hot fiber.	60947-4
AC-6a	Switching of transformers	60947-4
AC-6b	Switching of capacitors	60947-4
AC-7a	Switching low inductive loads of home appliances and similar applications	60947
AC-7b	Load of motors for home appliances	60947
AC-8a	Switching of hermetically sealed motors of cooling compressors with manual reset switches against overload Hermetically sealed cooling compressors have to be placed in one box without external shaft or shaft padding and motor must operate with cooling liquid	60947
AC-8b	Switching of hermetically sealed motors of cooling compressors with manual reset switches against overload Hermetically sealed cooling compressors have to be placed in one box without external shaft or shaft padding and motor must operate with cooling liquid	60947
AC-12	Switching of semiconductor loads with separation transformers	60947-5
AC-13	Switching of semiconductor loads with separation transformers	60947-5-1
AC-14	Switching of low electro-magnetic loads (max.72 VA)	60947-5-1
AC-15	Management of alternating electro-magnetic loads This category applies to switching inductive loads with input for closed electro-magnetic circuit higher than 72 VA Use: switching coils of contactors	60947-5
AC-20	Connecting and disconnecting in unloaded states	60947-3
AC-21	Switching resistive loads, including low loading	60947-3
AC-22	Switching of mixed resistive and inductive loads, including low overloading	60947-3
AC-23	Switching of motor loads or other high inductive loads	60947-3
AC-53a	Switching of motors with short-circuit armature with semiconductor contactors	60947

Note: Category AC 15 replaces formerly used category AC 11

DC current, $t = L/R$ (s)

DC-1	Non-inductive or low inductive load, resistive furnaces	60947-4
DC-3	Shunt motors: start-up, braking by backset, reversion, resistive braking	60947-4-1
DC-5	Series motor: start-up, braking by backset, reversion, resistive braking	60947-4-1
DC-6	Non-inductive or low inductive loads, resistive furnaces – el. bulbs	60947-4-1
DC-12	Management of resistive loads and fixed loads with insulation by opto-electric element	60947-5-1
DC-13	Switching of electromagnets	60947-5-1
DC-14	Switching of electromagnetic loads in circuits with limiting resistor	60947-5-1
DC-20a(b)	Switching and breaking without load(a: frequent switching ,b: occasional switching)	60947-3
DC-21a(b)	Switching ohmic loads including limiting overloading (a: frequent switching ,b: occasional switching)	60947-3
DC-22a(b)	Switching of compound ohmic and inductive loads including limited overloads (e.g. shunt motors) (a: frequent switching, b: random switching)	60947-3
DC-23	Switching of highly inductive loads (e.g. series motors)	60947-3

How can you distinguish for which load is our product (relay) designated?



















Our company record this information on a products and also in our catalogue, instruction manual and other promotional and technical material (website etc.).

It is important to realize that it is not always possible to point out load because of lack of information about the device (user cannot measure cos) or it is not possible because of inconstancy of parameters of switched device. Manufacturer of relays records always guaranteed parameters in ideal conditions which are done by a norm (temperature, pressure, humidity, etc.) and reality can be in a lot of cases different. Category of use (classification) of a particular relay is done by material of output contacts.



















Basic types of materials which are used for production of contacts for high-performance relay are:

- AgCd – suitable for switching ohmic loads. Before of harmfulness of Cd, this type of contact is remitted.
- AgNi – designated for switching resistive loads, good quality switching and conducting (contact doesn't oxidate) small currents/voltages, it is not designated for surge currents and loads with inductive component.
- AgSn or AgSnO₂ – suitable for switching loads with inductive component, not suitable for switching small currents/voltages, it is more resistive to surge currents, suitable for DC voltage switching, less suitable for switching loads of ohmic type.
- Wf (wolfram)-special contact designated for switching surge currents with inductive component.
- e) with gold (AgNi/Au)- Used for "improving" contacts for low currents/ voltages , prevents oxidation.

















RFJA-32B-SL; RFSA-62B-SL; RFSAI-62B-SL; RFSA-66M; RFSAI-11B-SL; RFSAI-62B-SL/TH; RFSW-62; RFSW-262; RFSTI-11B-SL; RFSAI-61B-SL; RFSA-61MI

Load type	 AC1 $\cos\phi \geq 0.95$	 AC2	 AC3	 AC5a without compensation	 AC5a with compensation	 AC5b	 AC6a	 AC7b	 AC12
Contact material AgSnO ₂ , Contact 8 A	250 V/8 A	250 V/5 A	250 V/4 A	x	x	250 W	250 V/4 A	250 V/1 A	250 V/1 A
Load type	 AC13	 AC14	 AC15	 DC1	 DC3	 DC5	 DC12	 DC13	 DC14
Contact material AgSnO ₂ , Contact 8 A	x	250 V/4 A	250 V/3 A	30 V/8 A	24 V/3 A	30 V/2 A	30 V/8 A	30 V/2 A	x

RFUS-61

Load type	 AC1 $\cos\phi \geq 0.95$	 AC2	 AC3	 AC5a without compensation	 AC5a with compensation	 AC5b	 AC6a	 AC7b	 AC12
Contact material AgSnO ₂ , Contact 14 A	250 V/12 A	250 V/5 A	250 V/3 A	230 V/3 A (690 VA)	230 V/3 A (690 VA) up to max input C=14uF	1000 W	x	250 V/3 A	x
Load type	 AC13	 AC14	 AC15	 DC1	 DC3	 DC5	 DC12	 DC13	 DC14
Contact material AgSnO ₂ , Contact 14 A	x	250 V/6 A	250 V/6 A	24 V/10 A	24 V/3 A	24 V/2 A	24 V/6 A	24 V/2 A	x

RFSA-61M; RFSC-61N; RFSA-61MI

Load type	 AC1 $\cos\phi \geq 0.95$	 AC2	 AC3	 AC5a without compensation	 AC5a with compensation	 AC5b	 AC6a	 AC7b	 AC12
Contact material AgSnO ₂ , Contact 16 A	250 V/16 A	250 V/5 A	250 V/3 A	230 V/3 A (690 VA)	230 V/3 A (690 VA) up to max input C=14uF	1000 W	x	250 V/3 A	250 V/10 A
Load type	 AC13	 AC14	 AC15	 DC1	 DC3	 DC5	 DC12	 DC13	 DC14
Contact material AgSnO ₂ , Contact 16 A	x	250 V/6 A	250 V/6 A	24 V/10 A	24 V/3 A	24 V/2 A	24 V/6 A	24 V/2 A	x

Rating of the light source ELKO lighting on dimmers ELKO EP

	LED bulb		LED spot lights			LED panels		LED / RGB strip					
	DLB-E27-806-2K7	DLB-E27-806-5K	DLSL-GU10-350-3K	LSL-GU10-350-3K	LSL-GU10-350-5K	LP-6060-3K	LP-6060-6K	LED strip 7.2W	LED strip 14.4W	LED strip 19.2W	LED strip 28.8W	RGB strip 7.2W	RGB strip 14.4W
RFDSC-71N	✓ number 21	✓ number 21	✓ number 45	✓ number 25	✓ number -	- number -	- number -	- number -	- number -	- number -	- number -	- number -	- number -
RFDEL-71B-SL	✓ 11	✓ 11	✓ 25	✓ 13	✓ 13	- -	- -	- -	- -	- -	- -	- -	- -
RFDA-73M/RGB	- -	- -	- -	- -	- -	- -	- -	✓ 3x8m	✓ 3x4m	✓ 3x5m	✓ 3x4m	✓ 20m	✓ 10m
RFDALI-32B-SL	- -	- -	- -	- -	- -	✓ 50	✓ 50	- -	- -	- -	- -	- -	- -

WARNING!

May lead to different results based on the state of network cable length and other factors.











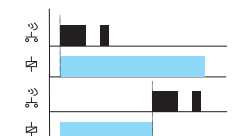
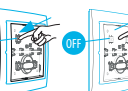
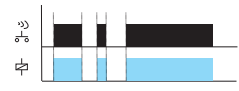
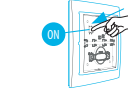



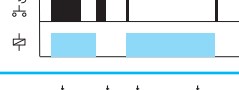
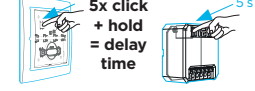

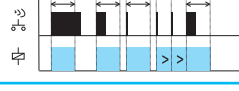

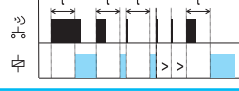

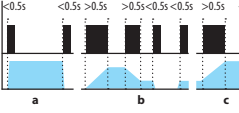
This table contains the results of tests that were conducted internally and therefore is ONLY for customers only informative. The products were tested in test laboratories ELKO EP, and therefore the company assumes no responsibility for any imitation test environment.

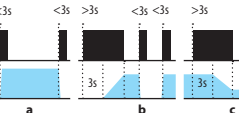
Inductive and capacitive loads must not be connected simultaneously!

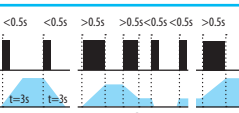
Load capacity:

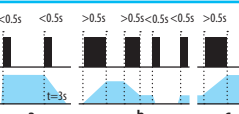
* Due to the huge amount of type of light sources, the maximum load depends on internal construction of dimmable LED and ESL bulbs and their power factor $\cos\phi$, capacity for power factor $\cos\phi=1$. The power factor of dimmable LEDs and ESL bulbs ranges from $\cos\phi=0.95$ up to 0.4. An approximate value of maximum load may be obtained by multiplying the load capacity of the dimmer by the power factor of the connected light source.

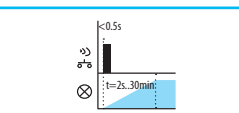
Table 2) Programming of feature functions

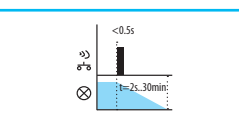
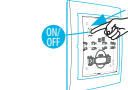
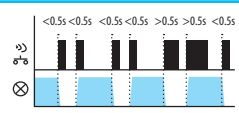
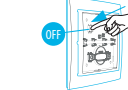
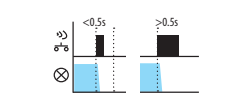
Single function - RFSA-11B-SL		
Assign a function	Feature description	Graph
 1x click	Function button ON/OFF The output contact closes by pressing one button position, and opens by releasing the button.	
It is a single-function relay, so when programming the ON function on the upper pusher, the OFF function is assigned to the button below it automatically		
Spínací prvky multifunkční - RFSA-61B, RFSA-62B-SL, RFSA-61M, RFSA-66M, RFSAI-62B-SL, RFSC-61N, RFUS-61		
 1x click	Function 1 - button The output contact will be closed by pressing the button and opened by releasing the button.	
 2x click	Function 2 - switch on The output contact will be closed by pressing the button.	
 3x click	Function 3 - switch off The output contact will be opened by pressing the button.	
 4x click	Function 4 - impulse relay The output contact will be switched to the opposite position by each press of the button. If the contact was closed, it will be opened and vice versa.	
 5x click + hold = delay time 	Function 5 - delayed off The output contact will be closed by pressing the button and opened after the set time interval has elapsed. $t = 2\text{ s} - 60\text{ min}$.	
 6x click + hold = delay time 	Function 6 - delayed on The output contact will be opened by pressing the button and closed after the set time interval has elapsed. $t = 2\text{ s} - 60\text{ min}$.	
The timing function (5 and 6) is performed by combining multiple presses and tracking the time for which we want to activate the delayed return or start (see. Manual for switching devices).		
Stmívací prvky multifunkční RFDA-73M/RGB, RFDEL-71B-SL, RFDEL-71M, RFDSC-71N, RFDAC-71B, RFDW-71		
 1x click	Light scene function 1 The brightness level is saved in the memory, and pressing the button shortly later will switch the light on/off to this intensity. It is possible to readjust the change in intensity at any time by a long press of the programmed button. The actuator remembers the adjusted value even after disconnecting from the power supply.	
 2x click	Light scene function 2 The brightness level is saved in the memory, and pressing the button shortly later will switch the light on/off to this intensity. It is possible to readjust the change in intensity at any time by pressing the programmed button for over 3 s. The actuator remembers the adjusted value even after disconnecting from the power supply.	
 3x click	Light scene function 3 The brightness level is saved in the memory, and pressing the button shortly later will switch the light on/off to this intensity. It is possible to readjust the change in intensity at any time by a long press of the programmed button. The actuator remembers the adjusted value even after disconnecting from the power supply.	
 4x click	Light scene function 4 The brightness level is saved in the memory, and pressing the button shortly later will switch the light on/off to this intensity. It is possible to readjust the change in intensity at any time by a long press of the programmed button. The actuator remembers the adjusted value even after disconnecting from the power supply.	
 5x Click + hold = time 	Function sunrise After pressing the programmed button, the light begins to illuminate in the programmed time interval in a range of 2 seconds to 30 minutes.	
 6x Click + hold = time 	Function sunset After pressing the programmed button, the light begins to dim in the programmed time interval in a range of 2 seconds to 30 minutes.	
 7x click	Function ON / OFF If the light is switched off, pressing the programmed button will switch it on. If the light is switched on, pressing the programmed button will switch it off.	
 8x click	Function switch OFF The dimmer output switches off by pressing the button.	

The sunrise and sunset function is performed by combining multiple presses and tracking the time for which we want to activate the delayed return or start (see. Manual for switching devices).

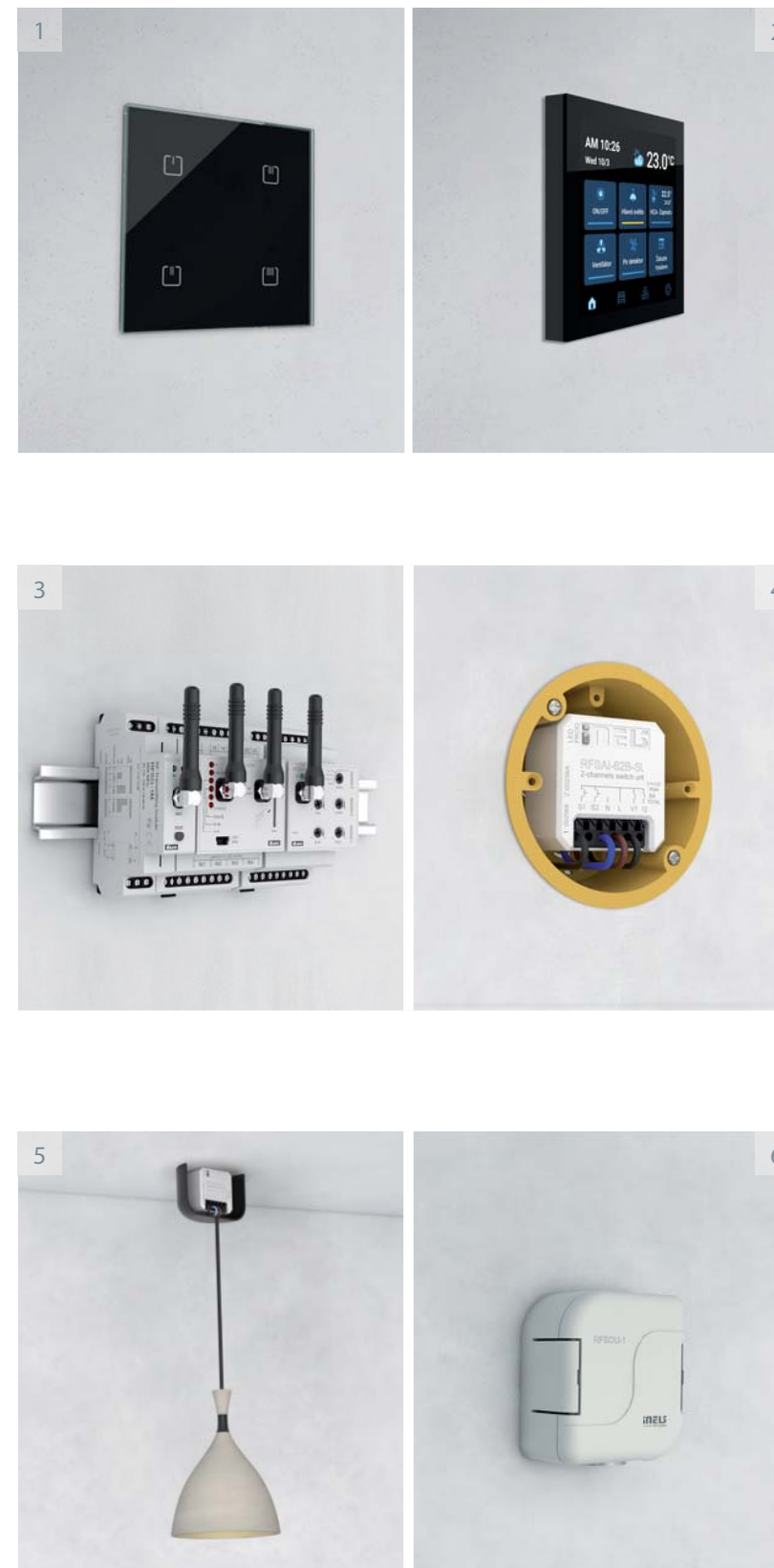

1) Surface mounted

Wall mounted or in an installation box with spacing of 65 mm.

- RFWB-20/G RFGB-40B/MT RFGB-220
- RFWB-40/G RFGB-40W/MT RFGB-240
- RFWB-40G/MT RFTC-10/G
- RFGB-20 RFTC-50/G
- RFGB-40 RFTC-150/G

2) Flush mounted

- RF Touch-2 RFSW-62/S
- RFDW-71
- RFDW-271
- RFGS-30/S

3) DIN Rail mounted

On DIN rail according to EN 60715.

- RFSG-1M RFSA-61M
- RFDA-73M/RGB RFSA-66M
- RFDEL-71M RFSA-66MI
- RFSA-266M RFSA-61MI
- RFDEL-76M

4) Flush mounted (BOX)

- RFIM-40B-BP-SL RFSAI-62B-SL
- RFIM-40B-230-SL RFSAI-61BPF-SL
- RFDALI-32B-SL RFJA-32B-SL
- RFDALI-04B-SL RFSTI-11B-SL
- RFDEL-71B-SL RFSAI-161B
- RFSAI-11B-SL RFSTI-111B
- RFSA-61B RFSAI-62B-SL/MT

5) Mounted into the cover of appliance

- RFDALI-32B-SL RFSAI-62B-SL RFSTI-111B
- RFDALI-04B-SL RFSAI-BPF-SL RFSAI-62B-SL/MT
- RFDEL-71B-SL RFJA-32B-SL
- RFSAI-11B-SL RFSTI-11B-SL
- RFSA-61B RFSAI-161B

6) Surface mounted

- RFSOU-1 RFDW-100
- RFUS-61 RFOWB-20
- RFTM-100 RFMD-200
- RFSF-100 RFSLT-S3
- RFMD-100

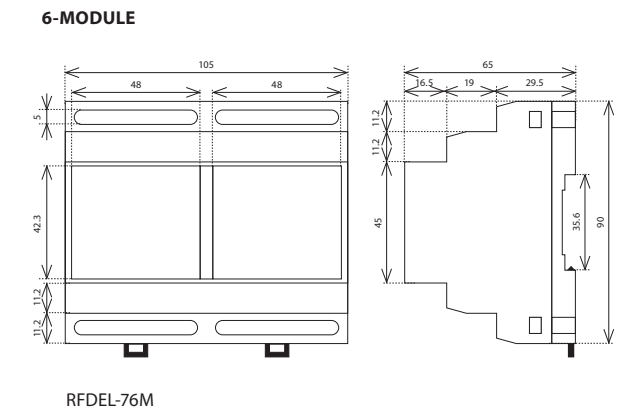
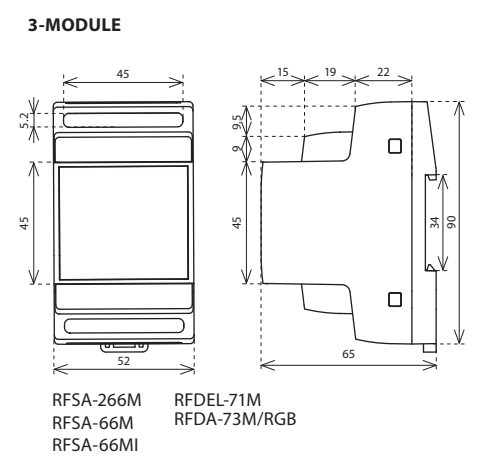
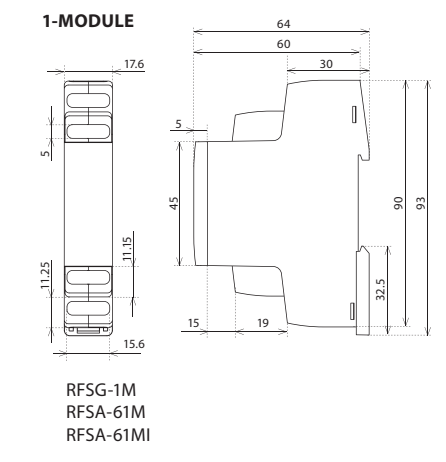
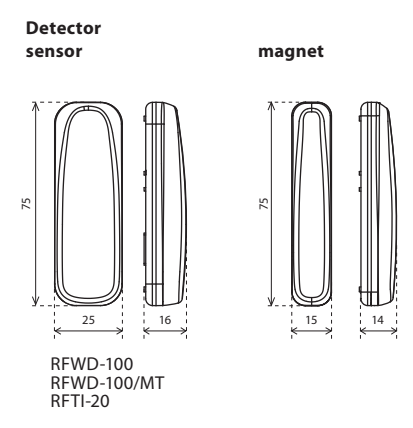
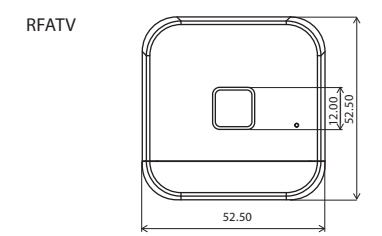
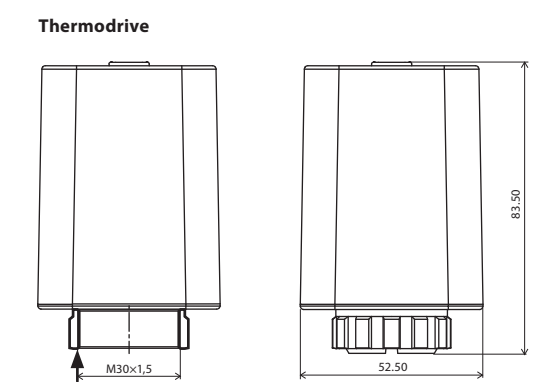
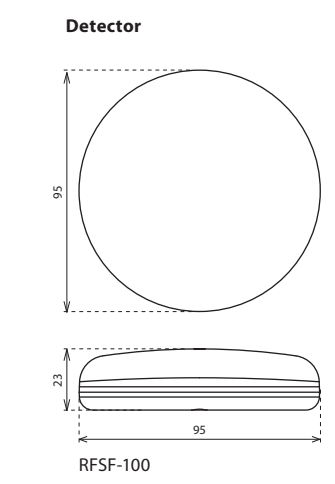
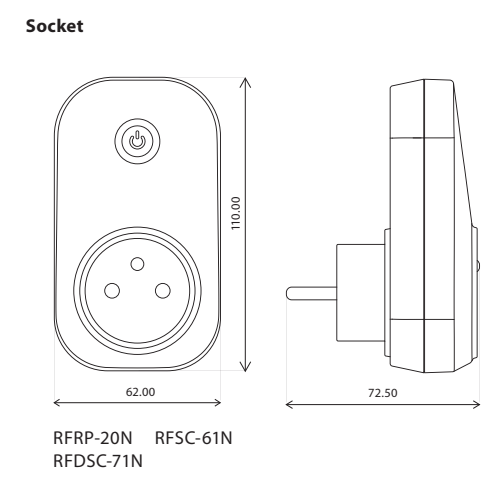
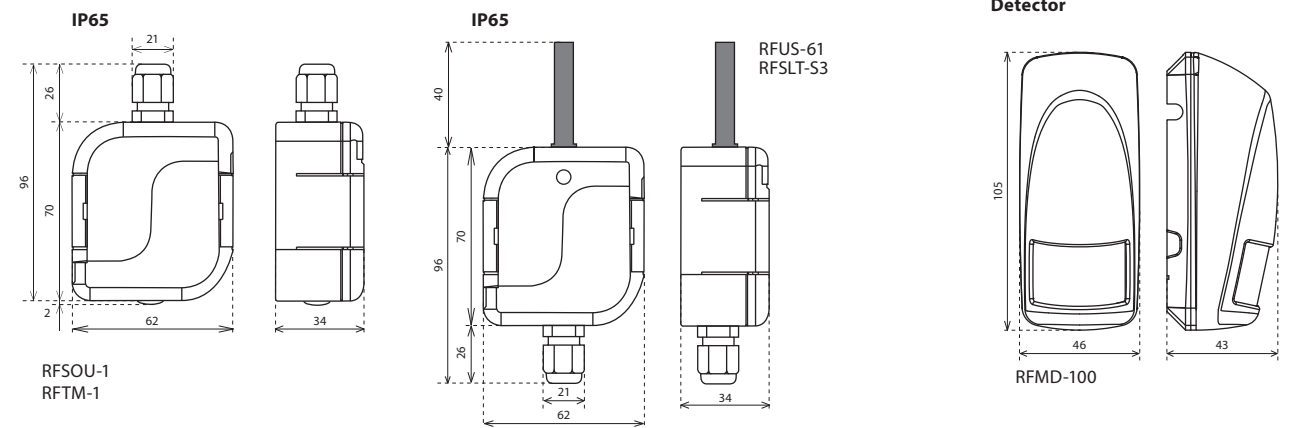
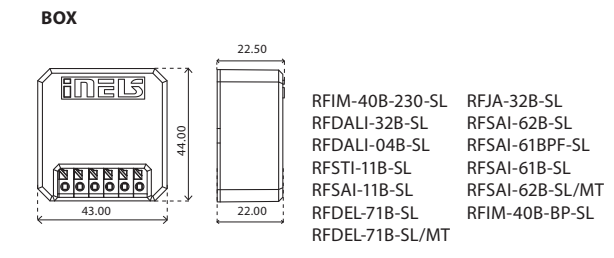
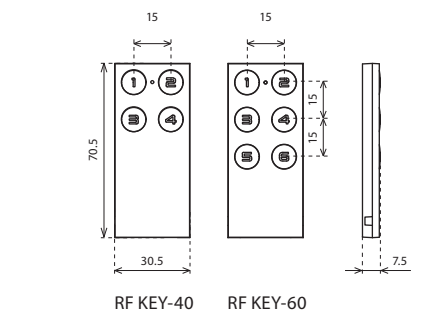
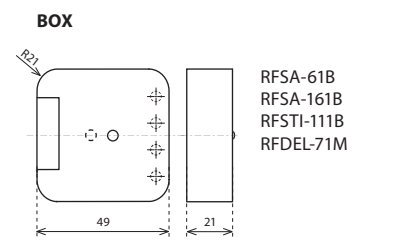
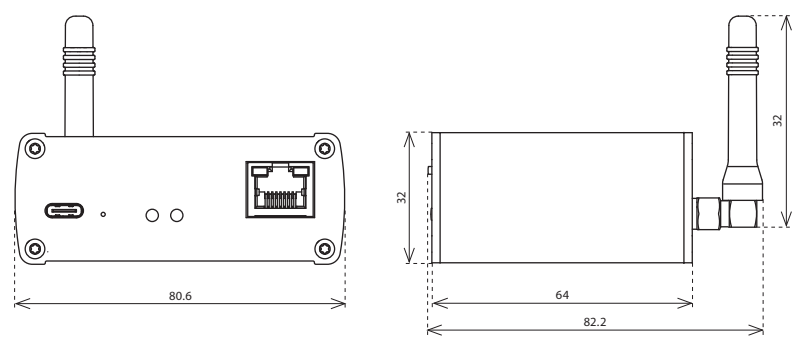
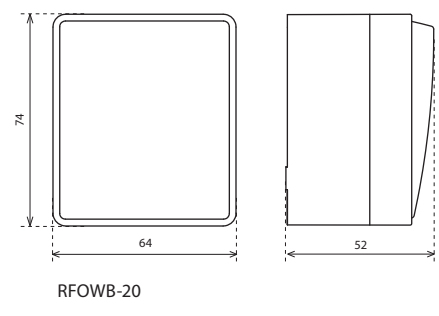
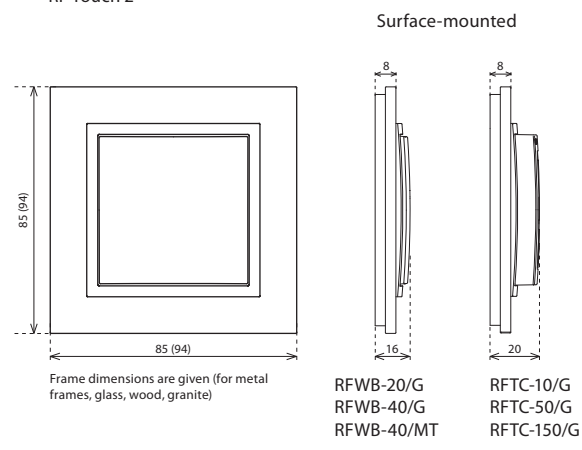
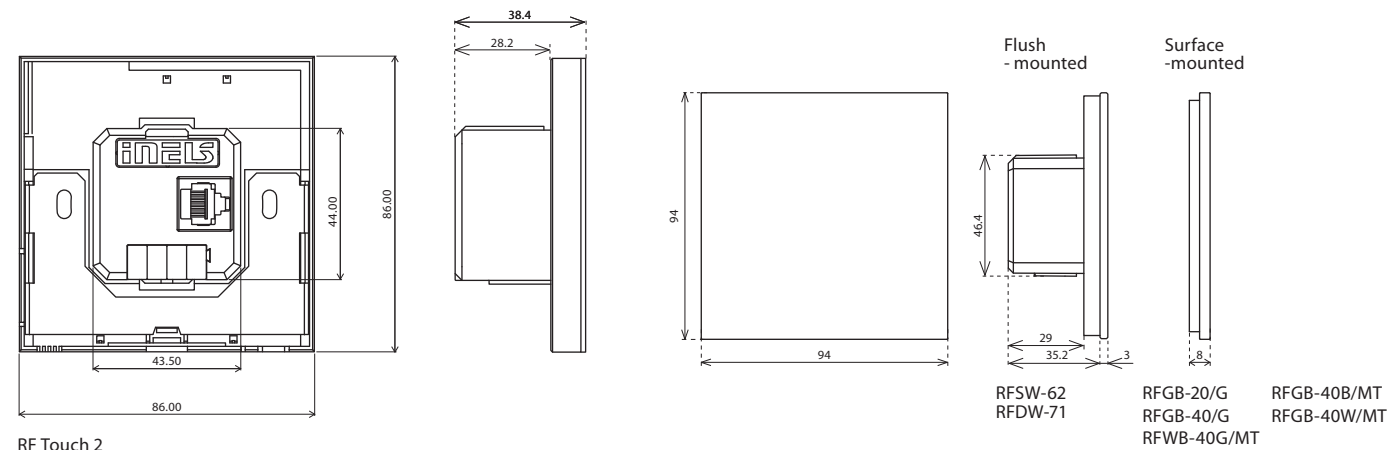

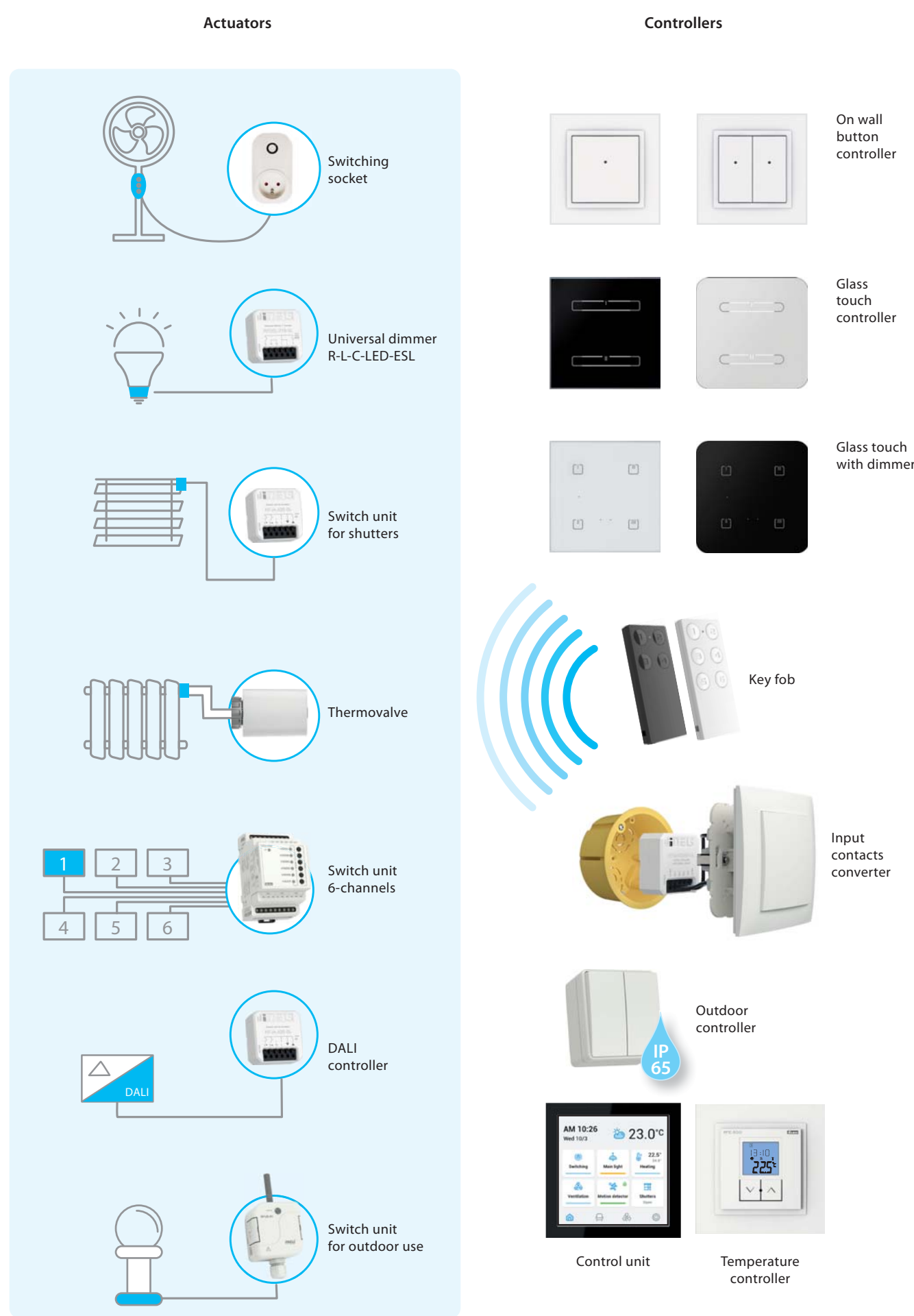
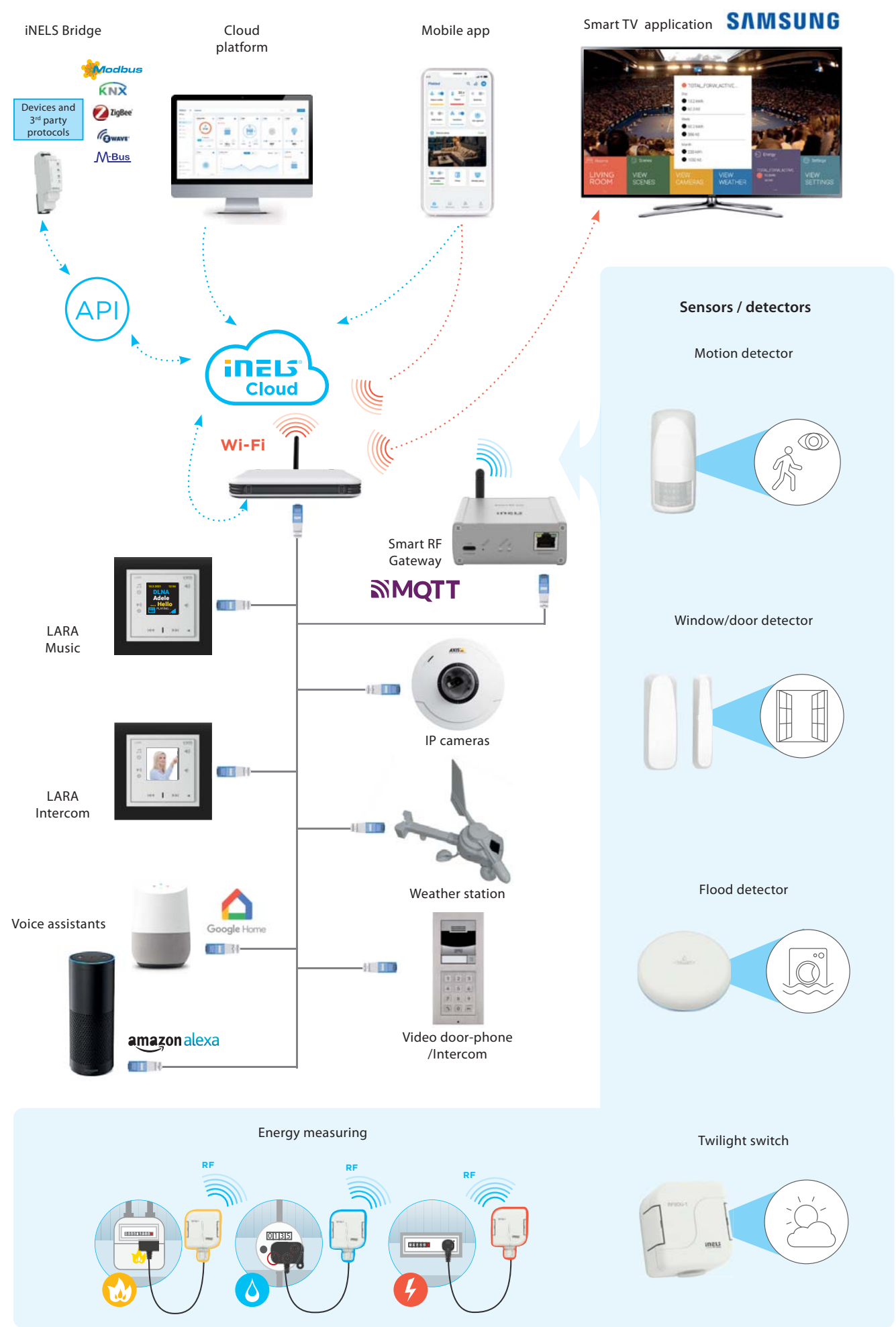



● **Headquarters**

ELKO EP Holding SE, Czech Republic

● **Europe**

ELKO EP Balkan d.o.o
ELKO EP Bulgaria OOD
ELKO EP Germany GmbH
ELKO EP Hungary Kft.
ELKO EP POLAND Sp. z o.o.
ELKO EP SLOVAKIA, s.r.o.
ELKO EP UK Ltd.
ELKO EP UKRAINE LLC

● **Africa & Middle East**

ELKO EP Egypt LLC
ELKO EP Kuwait Ltd.
ELKO EP MEA LLC
ELKO EP Saudi Arabia Ltd.
ELKO EP South Africa PTY Ltd.

● **America**

ELKO EP North America LLC



ELKO EP, s.r.o. | Palackeho 493 | 769 01 Holesov, Vsetuly | Czech Republic
phone: +420 573 514 221 | fax: +420 573 514 227 | elko@elkoep.com | www.elkoep.com

Published: 11/2023 | Modifications or amendments reserved | © Copyright ELKO EP, s.r.o. | 1st edition