



EAN kód
SA3-012M: 8595188132466
SA3-012M/120V: 8595188133029

Technické parametry SA3-012M SA3-012M/120V

Výstupy

Výstup:	12x spínací 8A/AC1
Spínané napětí:	250 V AC, 24 V DC
Spínaný výkon:	2000 VA / AC1, 192 W/DC
Špičkový proud:	10 A
Výstupy relé odděleny od všech vnitřních obvodů:	zesílená izolace (kat. přepětí II dle EN 60664-1)
Izolace mezi reléovými výstupy COM1, COM2 a COM3:	zesílená izolace (kat. přepětí II dle EN 60664-1)
Izolační napětí otevřeného kontaktu relé:	1 kV
Max. proud jednou společnou svorkou:	16A
Minimální spínaný proud:	100 mA / 10 V DC
Frekvence spínání bez zátěže:	300 min ⁻¹
Frekvence spínání se jm. zátěží:	15 min ⁻¹
Mechanická životnost:	1x 10 ⁷
Elektrická životnost AC1:	1x 10 ⁵
Indikace výstupu:	12x žlutá LED

Komunikace

Instalační sběrnice:	BUS
Instalační sběrnice BUS je oddělena od všech vnitřních obvodů:	zesílená izolace (kat. přepětí II dle EN 60664-1)
Indikace stavu jednotky:	zelená LED RUN

Napájení

Napájecí napětí BUS / tolerance / jmenovitý proud:	27V DC, -20 / +10 %, 5mA	
Napájecí napětí výkonové části (relé) / tolerance / jmenovitý proud:	AC 230V (50 Hz), -15 / +10 %, 20 mA	AC 120V (60 Hz), -15 / +10 %, 40 mA
Ztrátový výkon:	max. 6 W	max. 5 W

Připojení

Svorkovnice:	max. 2.5 mm ² / 1.5 mm ² s dutinkou
--------------	---

Provozní podmínky

Pracovní teplota:	-20 .. +55 °C
Skladovací teplota:	-30 .. +70 °C
Stupeň krytí:	IP20 přístroj, IP40 se zákrytem v rozvaděči
Kategorie přepětí:	II.
Stupeň znečištění:	2
Pracovní poloha:	libovolná
Instalace:	do rozvaděče na DIN lištu EN 60715
Provedení:	6-MODUL

Rozměry a hmotnost

Rozměry:	90 x 105 x 65 mm
Hmotnost:	310 g

- SA3-012M je spínací aktor vybavený 12 nezávislými relé se spínacími bezpotenciálovými kontakty.
- Maximální zatížitelnost kontaktů je 8 A / 2000 VA / AC1.
- Každý z výstupních kontaktů je samostatně ovladatelný a adresovatelný.
- Relé jsou rozděleny do tří čtveřic, kdy každá čtveřice spíná svůj společný potenciál.
- Aktor je určen pro spínání až dvanácti nejrůznějších spotřebičů a zátěží reléovým výstupem (bezpotenciálovým kontaktem).
- Aktor SA3-012M je napájen ze síťového napětí 230V AC. Aktor SA3-012M/120V je napájen ze síťového napětí 120V AC.
- Sběrnice BUS je galvanicky oddělena od vnitřních obvodů jednotky.
- LED diody na předním panelu signalizují stav každého výstupu.
- Pomocí ovládacích tlačítek na předním panelu lze měnit stav kontaktů jednotlivých relé manuálně a pro každé relé samostatně.
- Spínací aktory SA3-012M jsou standardně dodávány ve variantě materiálu kontaktu AgSnO₂.
- SA3-012M v provedení 6-MODUL je určen pro montáž do rozvaděče na DIN lištu EN60715.

Zapojení

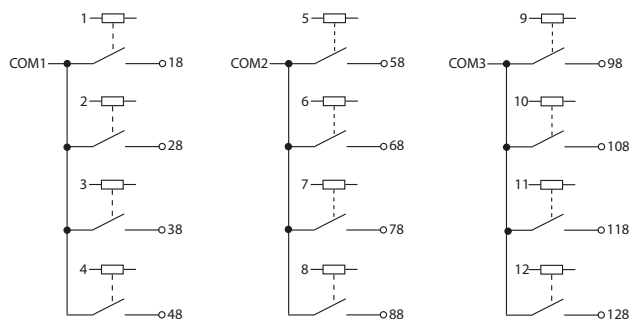
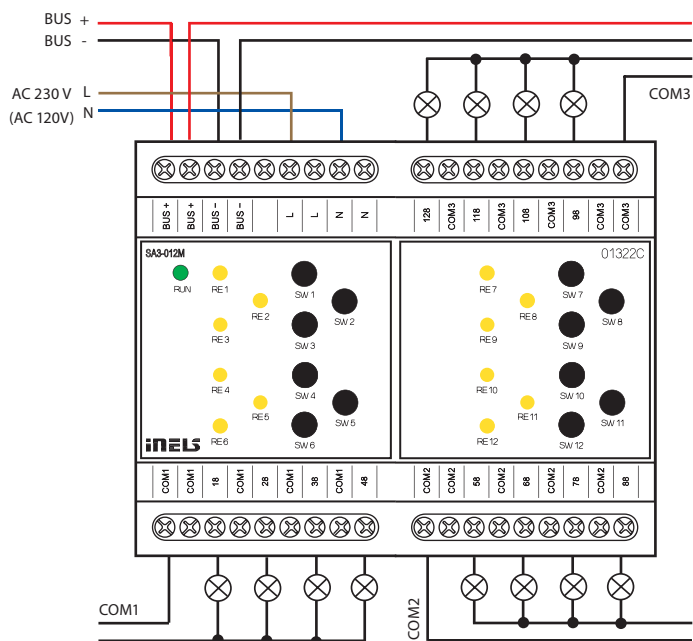

Zatížitelnost kontaktů výrobků iNELS



















Minimální zátěž

Kontakt relé	mV	V/mA
AgSnO ₂	1000	10/100



















Minimální zátěž

Kontakt relé	mV	V/mA
AgNi	300	5/10



















GCR3-11, GCH3-31, GMR3-61, SA3-02B, SA3-06M, SA3-012M, WMR3-21

druh zátěže	 cos φ ≥ 0.95								
mat. kontaktu AgSnO ₂ kontakt 8A	AC1 250V / 8A	AC2 250V / 2.5A	AC3 250V / 1.5A	AC5a nekompenzované 230V / 1.5A (345VA)	AC5a kompenzované do max. vstupní C=14uF	AC5b 250W	AC6a 250V / 4A	AC7b 250V / 1A	AC12 250V / 1A
druh zátěže									
mat. kontaktu AgSnO ₂ kontakt 8A	AC13 x	AC14 250V / 3A	AC15 250V / 3A	DC1 24V / 8A	DC3 24V / 3A	DC5 24V / 2A	DC12 24V / 8A	DC13 24V / 1A	DC14 x



















CU3-04M (RE7 - RE-10), LBC3-02M, SA3-01B, SA3-02M, SA3-04M, SA3-022M (RE7 - RE-10), EA3-022M (RE7 - RE-10), JA3-018M (U/D1 - U/D9)

druh zátěže	 cos φ ≥ 0.95								
mat. kontaktu AgSnO ₂ kontakt 16A	AC1 250V / 16A	AC2 250V / 5A	AC3 250V / 3A	AC5a nekompenzované 230V / 3A (690VA)	AC5a kompenzované do max. vstupní C=14uF	AC5b 1500W	AC6a x	AC7b 250V / 3A	AC12 250V / 10A
druh zátěže									
mat. kontaktu AgSnO ₂ kontakt 16A	AC13 250 / 6A	AC14 250V / 6A	AC15 250V / 6A	DC1 24V / 16A	DC3 24V / 6A	DC5 24V / 4A	DC12 24V / 16A	DC13 24V / 2A	DC14 24V / 2A





SA3-02B/Ni*, SA3-06M/Ni*, SA3-012M/Ni*

druh zátěže	 cos φ ≥ 0.95								
mat. kontaktu AgNi kontakt 8A	AC1 250V / 8A	AC2 250V / 2.5A	AC3 250V / 1.5A	AC5a nekompenzované 230V / 1.5A (345VA)	AC5a kompenzované x	AC5b 400W	AC6a x	AC7b 250V / 1.5A	AC12 250V / 5A
druh zátěže									
mat. kontaktu AgNi kontakt 8A	AC13 250 / 3A	AC14 250V / 3A	AC15 250V / 3A	DC1 24V / 8A	DC3 24V / 3A	DC5 24V / 2A	DC12 24V / 8A	DC13 24V / 1A	DC14 24V / 1A

SA3-01B/Ni*, SA3-06M/Ni*, SA3-04M/Ni*

druh zátěže	 cos φ ≥ 0.95								
mat. kontaktu AgNi kontakt 16A	AC1 250V / 16A	AC2 250V / 5A	AC3 250V / 3A	AC5a nekompenzované 230V / 3A (690VA)	AC5a kompenzované x	AC5b 800W	AC6a x	AC7b 250V / 3A	AC12 250V / 10A
druh zátěže									
mat. kontaktu AgNi kontakt 16A	AC13 250 / 6A	AC14 250V / 6A	AC15 250V / 6A	DC1 24V / 16A	DC3 24V / 6A	DC5 24V / 4A	DC12 24V / 16A	DC13 24V / 2A	DC14 24V / 2A

JA3-018M (U/D1 - U/D9),
 CU3-04M (RE1 - RE6, OUT1 - OUT2, RE11 - RE16),
 SA3-022M (RE1 - RE6, OUT1 - OUT2, RE11 - RE16, SHUTTER),
 EA3-022M (RE1 - RE6, OUT1 - OUT2, RE11 - RE16, SHUTTER),
 FA3-612M (FAN1 - FAN3, RE)

druh zátěže	 cos φ ≥ 0.95			
mat. kontaktu AgNi kontakt 6A	AC1 250V / 6A	AC3 230V / 0.8A	AC15 230V / 1.3A	DC1 30V / 3A 110V / 0.2A 220V / 0.12A

Znázorněné značky jsou informativní.

* Výrobky s kontaktem AgNi pouze na zakázku za příplatek.