



EAN kód
SA3-04M: 8595188132381

Technické parametry

SA3-04M

Výstupy

Výstup:	4x přepínací 16A/AC1
Spínané napětí:	250 V AC, 24 V DC
Spínaný výkon:	4000 VA / AC1, 384 W/DC
Špičkový proud:	30 A; max. 4 s. při střídě 10%
Výstupy relé odděleny od všech vnitřních obvodů:	zesílená izolace (kat. přepětí II dle EN 60664-1)
Izolace mezi reléovými výstupy RE1-3 a RE4:	zesílená izolace (kat. přepětí II dle EN 60664-1)
Izolace mezi reléovými výstupy RE1-3:	základní izolace (kat. přepětí II dle EN 60664-1)
Izolační napětí otevřeného kontaktu relé:	1 kV
Minimální spínaný proud:	100 mA
Frekvence spínání bez zátěže:	1200 min ⁻¹
Frekvence spínání se jm. zátěží:	6 min ⁻¹
Mechanická životnost:	3x 10 ⁷
Elektrická životnost AC1:	0.7x 10 ⁵
Indikace výstupu:	4x žlutá LED

Komunikace

Instalační sběrnice:	BUS
----------------------	-----

Napájení

Napájecí napětí / tolerance:	27 V DC, -20 / +10 %
Ztrátový výkon:	max. 4 W
Jmenovitý proud:	70 mA (při 27V DC), ze sběrnice BUS
Indikace stavu jednotky:	zelená LED RUN

Připojení

Svorkovnice:	max. 2.5 mm ² /1.5 mm ² s dutinkou
--------------	--

Provozní podmínky

Vzdušná vlhkost:	max. 80 %
Pracovní teplota:	-20 .. +55 °C
Skladovací teplota:	-30 .. +70 °C
Stupeň krytí:	IP20 přístroj, IP40 se zákrytem v rozvaděči
Kategorie přepětí:	II.
Stupeň znečištění:	2
Pracovní poloha:	libovolná
Instalace:	do rozvaděče na DIN lištu EN 60715
Provedení:	3-MODUL

Rozměry a hmotnost

Rozměry:	90 x 52 x 65 mm
Hmotnost:	164 g

- SA3-04M je spínací aktor vybavený 4 nezávislými relé s přepínacími bezpotenciálovými kontakty.
- Maximální zatížitelnost kontaktů je 16A / 4000 VA / AC1.
- Každý z výstupních kontaktů je samostatně ovladatelný a adresovatelný.
- Všechna čtyři relé mají samostatně vyvedené vstupní svorky, a proto mohou spínat různé nezávislé potenciály.
- Aktor je určen pro spínání až čtyř nejrůznějších spotřebičů a zátěží reléovým výstupem (bezpotenciálovým kontaktem).
- Díky přepínacím kontaktům lze aktor využít pro ovládání až dvou pohonů 230V (např. žaluzií, rolet nebo markýz), přičemž vhodným propojením kontaktů lze zabezpečit hardwarové zablokování možnosti současného sepnutí fáze na oba výstupy, viz. příklad zapojení.
- LED diody na předním panelu signalizují stav každého výstupu.
- Pomocí ovládacích tlačítek na předním panelu lze měnit stav kontaktů jednotlivých relé manuálně a pro každé relé samostatně.
- Spínací aktory SA3-04M jsou standardně dodávány ve variantě materiálu kontaktu AgSnO₂.
- SA3-04M v provedení 3-MODUL je určen pro montáž do rozvaděče na DIN lištu EN60715.

Zapojení

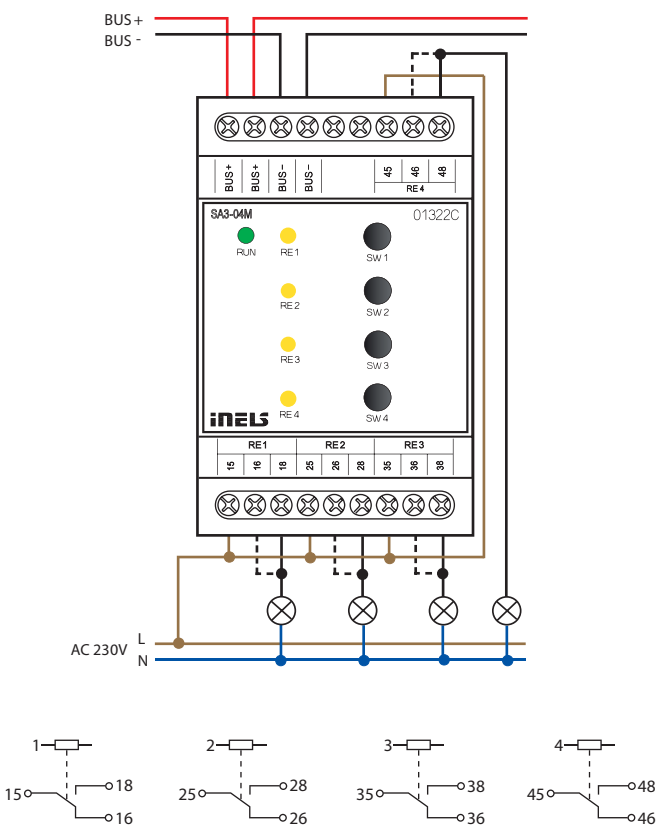

Zatížitelnost kontaktů výrobků iNELS



















Minimální zátěž

Kontakt relé	mV	V/mA
AgSnO ₂	1000	10/100



















Minimální zátěž

Kontakt relé	mV	V/mA
AgNi	300	5/10



















GCR3-11, GCH3-31, GMR3-61, SA3-02B, SA3-06M, SA3-012M, WMR3-21

druh zátěže	 cos φ ≥ 0.95								
mat. kontaktu AgSnO ₂ kontakt 8A	AC1 250V / 8A	AC2 250V / 2.5A	AC3 250V / 1.5A	AC5a nekompensované 230V / 1.5A (345VA)	AC5a kompenzované do max. vstupní C=14uF	AC5b 250W	AC6a 250V / 4A	AC7b 250V / 1A	AC12 250V / 1A
druh zátěže									
mat. kontaktu AgSnO ₂ kontakt 8A	AC13 x	AC14 250V / 3A	AC15 250V / 3A	DC1 24V / 8A	DC3 24V / 3A	DC5 24V / 2A	DC12 24V / 8A	DC13 24V / 1A	DC14 x



















CU3-04M (RE7 - RE-10), LBC3-02M, SA3-01B, SA3-02M, SA3-04M, SA3-022M (RE7 - RE-10), EA3-022M (RE7 - RE-10), JA3-018M (U/D1 - U/D9)

druh zátěže	 cos φ ≥ 0.95								
mat. kontaktu AgSnO ₂ kontakt 16A	AC1 250V / 16A	AC2 250V / 5A	AC3 250V / 3A	AC5a nekompensované 230V / 3A (690VA)	AC5a kompenzované do max. vstupní C=14uF	AC5b 1500W	AC6a x	AC7b 250V / 3A	AC12 250V / 10A
druh zátěže									
mat. kontaktu AgSnO ₂ kontakt 16A	AC13 250 / 6A	AC14 250V / 6A	AC15 250V / 6A	DC1 24V / 16A	DC3 24V / 6A	DC5 24V / 4A	DC12 24V / 16A	DC13 24V / 2A	DC14 24V / 2A





SA3-02B/Ni*, SA3-06M/Ni*, SA3-012M/Ni*

druh zátěže	 cos φ ≥ 0.95								
mat. kontaktu AgNi kontakt 8A	AC1 250V / 8A	AC2 250V / 2.5A	AC3 250V / 1.5A	AC5a nekompensované 230V / 1.5A (345VA)	AC5a kompenzované x	AC5b 400W	AC6a x	AC7b 250V / 1.5A	AC12 250V / 5A
druh zátěže									
mat. kontaktu AgNi kontakt 8A	AC13 250 / 3A	AC14 250V / 3A	AC15 250V / 3A	DC1 24V / 8A	DC3 24V / 3A	DC5 24V / 2A	DC12 24V / 8A	DC13 24V / 1A	DC14 24V / 1A

SA3-01B/Ni*, SA3-06M/Ni*, SA3-04M/Ni*

druh zátěže	 cos φ ≥ 0.95								
mat. kontaktu AgNi kontakt 16A	AC1 250V / 16A	AC2 250V / 5A	AC3 250V / 3A	AC5a nekompensované 230V / 3A (690VA)	AC5a kompenzované x	AC5b 800W	AC6a x	AC7b 250V / 3A	AC12 250V / 10A
druh zátěže									
mat. kontaktu AgNi kontakt 16A	AC13 250 / 6A	AC14 250V / 6A	AC15 250V / 6A	DC1 24V / 16A	DC3 24V / 6A	DC5 24V / 4A	DC12 24V / 16A	DC13 24V / 2A	DC14 24V / 2A

JA3-018M (U/D1 - U/D9),
CU3-04M (RE1 - RE6, OUT1 - OUT2, RE11 - RE16),
SA3-022M (RE1 - RE6, OUT1 - OUT2, RE11 - RE16, SHUTTER),
EA3-022M (RE1 - RE6, OUT1 - OUT2, RE11 - RE16, SHUTTER),
FA3-612M (FAN1 - FAN3, RE)

druh zátěže	 cos φ ≥ 0.95			
mat. kontaktu AgNi kontakt 6A	AC1 250V / 6A	AC3 230V / 0.8A	AC15 230V / 1.3A	DC1 30V / 3A 110V / 0.2A 220V / 0.12A

Znázorněné značky jsou informativní.

* Výrobky s kontaktem AgNi pouze na zakázku za příplatek.