

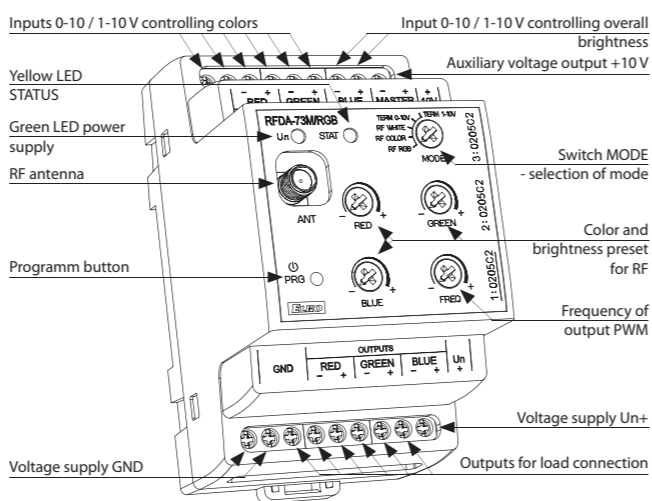

- The dimmer for LED strips is used for independent control of 3 single-color LED strips or one RGB LED strip.
- The expanded selection of control modes enables it to be combined with:
 - Detectors, Controllers and System units iNELS RF Control
 - control signal 0(1)-10 V
 - connecting to iNELS BUS using DAC converters.
- The unit's three-module design with switchboard mounting enables connection of dimmed load 3x 5 A, which represents:
 - single-color LED strip 7.2 W (ELKO Lighting) – 3x 8 m
 - RGB LED strip 14.2 W (ELKO Lighting) – 10 m.
- 6 light functions - smooth increase or decrease with time setting 2 s-30 min.
- When switched off, the set level is stored in the memory, and when switched back on, it returns to the most recently set value.
- The dimmer may be controlled by up to 32 channels (1 channel represents 1 button on the controller).
- The power supply of the unit is in the range of 12-24 V DC, and is indicated by a green LED.
- The package includes an internal antenna AN-I, in case of locating the unit in a metal switchboard, you can use the external antenna AN-E for better signal reception.
- Memory status can be pre-set in the event of a power failure.
- For components it is possible to set the repeater function via the RFAF / USB service device.
- Range up to 160 m (in open space), if the signal is insufficient between the controller and unit, use the signal repeater RFRP-20 or protocol component RFIO² that support this feature.
- Communication frequency with bidirectional protocol iNELS RF Control² (RFIO²).

Device description



Function

For more information see p. 75.

Output variations

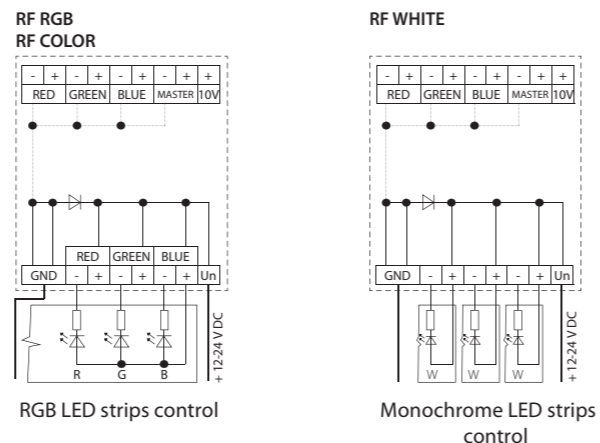

Control modes

RF RGB

Switch settings in MODE:

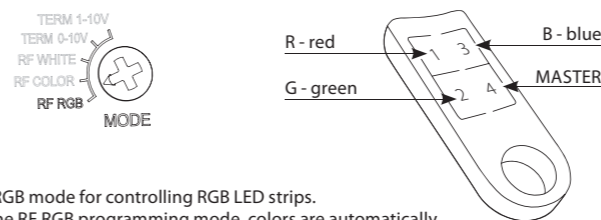

RF RGB mode for controlling RGB LED strips. In the RF RGB programming mode, colors are automatically assigned to individual transmitter buttons.

Note: The mode can be controlled by RF Touch, RF Pilot, RFWB-40/G, RF KEY, RFIM-40B, eLAN-RF-003 and eLAN-RF-Wi-003.

RF WHITE

Switch settings in MODE:

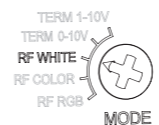

This works in a mode where it acts like three independent dimmers for 12-24 V. Each channel can be programmed independently of one another and has its own address.

Note: The mode can be controlled by RF Touch, RF Pilot, RFWB-20/G, RFWB-40/G, RF KEY, RFIM-20B, RFIM-40B, eLAN-RF-003 and eLAN-RF-Wi-003.

Control options

TERM 0(1)-10 V DC - monochrome LED strips

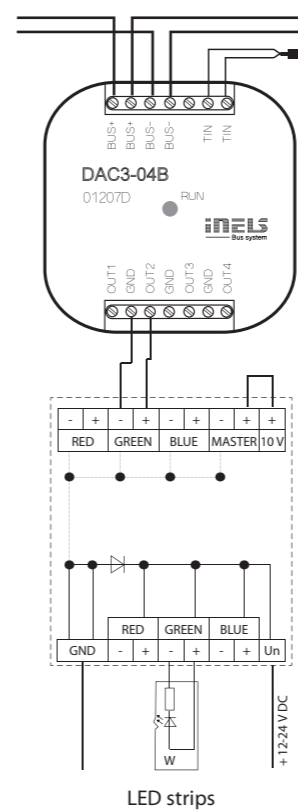

TERM 0(1)-10 V DC - RGB LED strips

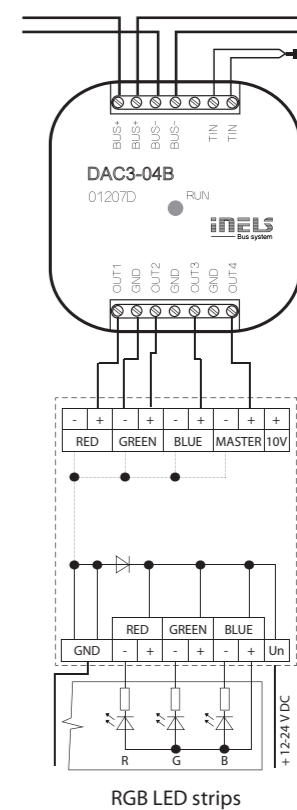

RF COLOR

Switch settings in MODE:

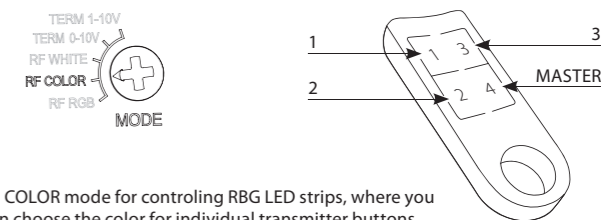

RF COLOR mode for controlling RGB LED strips, where you can choose the color for individual transmitter buttons. A long press of the button starts the color search mode. After releasing the button, the current color is set for the given button.

Note: The mode can be controlled by RF Touch, RF Pilot, RFWB-40/G, RF KEY RFIM-40B, eLAN-RF-003 and eLAN-RF-Wi-003.

TERM 0-10 V and TERM 1-10 V

Switch settings in MODE:



Modes TERM 0-10 V and TERM 1-10 V. Inputs 0-10 V and 1-10 V used to control one RGB LED strip or three independent single-color LED strips (see modes above) from the iNELS BUS System. For controlling, you can use the application iMM on the TV screen or the application iHC for smartphones and tablets.

* Max Tightening Torque for antenna connector is 0.56 Nm.

Multi function RFDA-73M/RGB, RFDEL-71B, RFDEL-71M, RFDSC-71, RFDAC-71B, RFDW-71

Light scene function 1

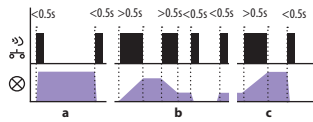

- a) By pressing the programmed button for less than 0.5 s, the light illuminates; it goes out by pressing again.
 - b) By pressing the programmed button for more than 0.5 s, fluid brightness regulation will occur. After releasing the button, the brightness level is saved in the memory, and pressing the button shortly later will switch the light on/off to this intensity.
 - c) It is possible to readjust the change in intensity at any time by a long press of the programmed button.
- The actuator remembers the adjusted value even after disconnecting from the power supply.

Light scene function 3

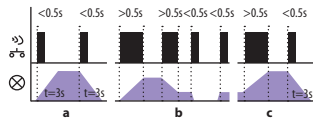

- a) By pressing the programmed button for less than 0.5 s, the light fluidly illuminates for a period of 3 s (at 100% brightness). By pressing the button shortly again, the light will continuously switch off for 3 seconds.
 - b) By pressing the programmed button for more than 0.5 s, fluid brightness regulation will occur. After releasing the button, the brightness level is saved in the memory, and pressing the button shortly later will switch the light on/off to this intensity.
 - c) It is possible to readjust the change in intensity at any time by a long press of the programmed button.
- The actuator remembers the adjusted value even after disconnecting from the power supply.

Function sunrise

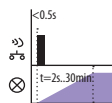

After pressing the programmed button, the light begins to illuminate in the programmed time interval in a range of 2 seconds to 30 minutes.

Function ON/OFF

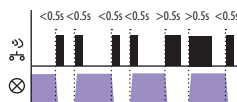

If the light is switched off, pressing the programmed button will switch it on. If the light is switched on, pressing the programmed button will switch it off.

Light scene function 2

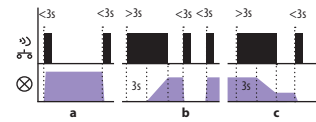

- a) By pressing the programmed button for less than 3 s, the light illuminates; it goes out by pressing again.
 - b) In order to limit undesirable control of brightness, fluid brightness control occurs only by pressing a programmed button for over 3 s. After releasing the button, the brightness level is saved in the memory, and pressing the button shortly later will switch the light on/off to this intensity.
 - c) It is possible to readjust the change in intensity at any time by pressing the programmed button for over 3 s.
- The actuator remembers the adjusted value even after disconnecting from the power supply.

Light scene function 4

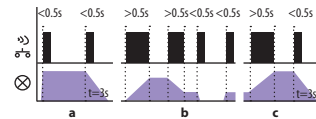

- a) By pressing the programmed button for less than 0.5 s, the light illuminates. By pressing the button shortly again, the light will continuously switch off for 3 seconds (at 100% brightness).
 - b) By pressing the programmed button for more than 0.5 s, fluid brightness regulation will occur. After releasing the button, the brightness level is saved in the memory, and pressing the button shortly later will switch the light on/off to this intensity.
 - c) It is possible to readjust the change in intensity at any time by a long press of the programmed button.
- The actuator remembers the adjusted value even after disconnecting from the power supply.

Function sunset

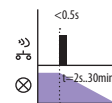

After pressing the programmed button, the light begins to dim in the programmed time interval in a range of 2 seconds to 30 minutes.

Function switch off

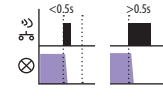

The dimmer output switches off by pressing the button.

Rating of the light source ELKO lighting on dimmers ELKO EP

	LED bulb		LED spot lights			LED panels		LED / RGB strip					
	DLB-E27-806-2K7	DLB-E27-806-5K	DLSL-GU10-350-3K	LSL-GU10-350-3K	LSL-GU10-350-5K	LP-6060-3K	LP-6060-6K	LED strip 7.2W	LED strip 14.4W	LED strip 19.2W	LED strip 28.8W	RGB strip 7.2W	RGB strip 14.4W
RFDSC-71	✓ 21	✓ 21	✓ 45	✓ 25	✓ -	- -	- -	- -	- -	- -	- -	- -	- -
RFDEL-71B	✓ 11	✓ 11	✓ 25	✓ 13	✓ 13	- -	- -	- -	- -	- -	- -	- -	- -
RFDA-73M/RGB	- -	- -	- -	- -	- -	- -	- -	✓ 3x8m	✓ 3x4m	✓ 3x5m	✓ 3x4m	✓ 20m	✓ 10m
RFDAC-71B	- -	- -	- -	- -	- -	✓ 50	✓ 50	- -	- -	- -	- -	- -	- -

WARNING!

May lead to different results based on the state of network cable length and other factors.

This table contains the results of tests that were conducted internally and therefore is ONLY for customers only informative. The products were tested in test laboratories ELKO EP, and therefore the company assumes no responsibility for any imitation test environment.

Inductive and capacitive loads must not be connected simultaneously!